



REPUBLIC OF UGANDA

**JUSTICE LAW AND ORDER SECTOR
(JLOS)**

**STRATEGIC INVESTMENT PLAN II
2006/7- 2010/11**

**CONSOLIDATING GAINS
AND
ENHANCING IMPACT**

FINAL DRAFT

AUGUST 2006

TABLE OF CONTENTS

SECTION I: PREFACE	2
SECTION II: EXECUTIVE SUMMARY	10
SECTION III: INTRODUCING THE SECTOR AND.....	15
CHAPTER 1: LEGAL, POLICY AND OPERATIONAL FRAMEWORK.....	16
1.1 INTRODUCTION.....	16
1.2 INTERNATIONAL AND REGIONAL TREATY OBLIGATIONS	16
1.3 SECTOR SET-UP AND STAKEHOLDERS	17
1.4 MANAGEMENT AND CO-ORDINATION MECHANISMS.....	17
1.5 SOCIO-ECONOMIC CONTEXT	17
1.6 NATIONAL POLICY FRAMEWORK.....	20
1.7 JLOS AS PART OF ONGOING NATIONAL REFORMS	22
1.8 JLOS POLICY FRAMEWORK.....	22
CHAPTER 2: A REFLECTION ON SIP I	23
2.1 UNDERSTANDING THE REFORM PROCESS.....	23
2.2 RESPECTING THE PAST: LEARNING FROM SIP I.....	23
2.3 ACHIEVEMENTS AND LESSONS LEARNT UNDER SIP I.....	24
2.4 ONGOING WORK TO CONSTITUTE PART OF SIP II:.....	25
2.5 TOWARDS SIP II: EXPANDING THE SCOPE.....	26
2.6 BROAD SECTORAL CHALLENGES PRECEDING SIP II.....	29
SECTION IV: THE REFORM PROCESS UNDER SIP II.....	32
3.1 JLOS PRINCIPLES.....	33
3.2 JLOS GOAL, PURPOSE AND OBJECTIVES	33
3.3 PRIORITY AREAS FOR REFORM OVER THE MEDIUM TERM	1
3.4 PROGRAMME AREAS AND ACTIVITIES UNDER KEY RESULT AREAS	35
3.5 PROGRAMME MANAGEMENT	47
CHAPTER 4: STRATEGY TO IMPLEMENT SIP II.....	48
4.1 STRATEGIES TO ACHIEVE THE JLOS OBJECTIVES	48
4.2 UTILIZING INTER-SECTORAL LINKAGES AND COLLABORATION	52
4.3 EFFECTIVE PARTICIPATION OF CSOs AND THE PRIVATE SECTOR	54
4.4 KEY RISKS, ASSUMPTIONS, AND SUSTAINABILITY ISSUES.....	57
CHAPTER 5: PROGRAMME MANAGEMENT (STRUCTURES AND PROCESSES).....	58
5.1 PROGRAMME MANAGEMENT (STRUCTURES AND PROCESSES).....	58
5.2 THE MANAGEMENT STRUCTURE.....	58
5.3 MANAGEMENT PROCESSES	63
CHAPTER 6: MONITORING AND EVALUATION.....	66
6.1 INTRODUCTION:	66
6.2 M&E GAPS IN JLOS	66
6.3 THE NATIONAL M&E FRAMEWORK:.....	67
6.4 THE JLOS M&E FRAMEWORK:	68
6.5 JLOS MONITORING AND PROGRAMME MANAGEMENT CYCLE OVER SIP II:	69
6.6 M&E ROLES AND RESPONSIBILITIES	70
6.7 REVIEWS AND EVALUATIONS.....	71
CHAPTER 7: FINANCING THE REFORM PROCESS	72
7.1 MTEF AND AFFORDABILITY ANALYSIS:	72
7.3 LOW COST INITIATIVES AND NON TAX REVENUE	75
7.4 FINANCIAL MANAGEMENT AND PROCEDURES	76
7.5 BUDGET FOR 2006/07 AND THE SIP II PERIOD.....	77
CHAPTER 8: TRANSITION ARRANGEMENTS FROM SIP I TO SIP II	82
8.1 EXPANSION OF FOUR FOCUS AREAS	82
8.2 RECONSTITUTION OF THE VARIOUS MANAGEMENT STRUCTURES	82
8.3 ESTABLISHMENT OF WORKING GROUPS UNDER THE FOUR FOCUS AREAS:.....	82
8.4 INTEGRATION OF PARALLEL STRUCTURES AT THE NATIONAL LEVEL	83
8.5 ESTABLISHMENT OF JLOS COORDINATION COMMITTEES (JCC).....	83
8.6 FINANCIAL MANAGEMENT- RATIONALISATION OF THE THREE PAF PROTECTED FUNDS	83
8.7 ENHANCING AWARENESS AND PROFILE OF JLOS AMONG STAFF AND AT HIGHER LEVELS	83

SECTION I: PREFACE

FOREWORD

Government has over the last six years implemented policies through a sector wide approach in the Justice Law and Order Sector that aimed at delivering quality justice efficiently and effectively. This has led to increased confidence in the justice system as a result of increased safety and security, and enhanced access to justice.

The Justice Law and Order Sector Strategic Investment Plan II for the period 2006/2007 to 2010/2011 is a result of many months of preparation by the JLOS institutions that was characterized by extensive participation and consultation within the JLOS and with its stakeholders and partners. It brings continuity to the reforms that were started under the first Strategic Investment Plan I (2001/2002 to 2006/2007) whose implementation resulted in many achievements at output and impact levels. This collaborative approach emphasizes a growing awareness that the challenges within the Justice Law and Order Sector can only be successfully addressed by working together.

There are still many concerns in the Justice Law and Order Sector in Uganda that require improvements and actions. The Strategic Investment Plan II consolidates the gains that were realized over the years under the first Strategic Investment Plan and further addresses these challenging realities. The complexities of delivery of justice and maintenance of law and order influence public and user perceptions, demand, usage of the services, and whether or how the public supports the JLOS and vice versa. The Strategic Investment Plan II is therefore for and about the people in Uganda. In anchoring the Plan on the real and specific issues that the people desire to see improvements in, we identified appropriate approaches to tackle the challenges in the justice system.

Increasing the impact of efficient and effective justice delivery is fundamental for poverty reduction, economic development and growth. The Strategic Investment Plan is an expression of Government's commitment and determination to meet these aspirations not only as legal issues, but also to address them as cultural, social, and economic issues that affect all other sectors of Ugandan society and every Ugandan.

The Strategic Investment Plan II will therefore guide the JLOS interventions over the next five years to fulfil our mandate through a motivated workforce to enable all people particularly the vulnerable to access timely and equitable justice. Let us today, and in the years ahead, join the efforts of the justice law and order sector to ensure that the Plan is translated into concrete, focused and sustained national action.

Hon. (Dr.) E. Khiddu Makubuya MP.
Attorney General and Minister of Justice and Constitutional Affairs

August 2006

ACKNOWLEDGEMENTS

The Justice Law and Order Sector (JLOS) Strategic Investment Plan II (SIP II) is a product of a series of consultations that were facilitated by the Nordic Consulting Group. A SIP II Task Force was constituted comprising representatives from the JLOS Technical Committee, the JLOS Secretariat and the JLOS Development Partners Group to provide technical backstopping throughout the strategic planning process.

We acknowledge the support, assistance and commitment of various stakeholders and partners in this process. The JLOS Leadership and Steering Committee provided overall political and policy guidance and direction for the Plan, while the JLOS Technical Committee and the JLOS institutions namely the Ministry of Justice and Constitutional Affairs, the Ministry of Internal Affairs, the Judiciary, the Uganda Police Force, the Uganda Prisons Service, the Judicial Service Commission, the Directorate of Public Prosecutions, the Uganda Law Reform Commission, the Ministry of Local Government - Local Council Courts, the Ministry of Gender, Labour and Social Development - Probation Services and its associate institutions namely the Tax Appeals Tribunal, the Uganda Law Society, the Centre for Arbitration and Dispute Resolution (CADER) and the Law Development Centre showed continued determination and commitment to make detailed contribution to the plan.

External stakeholders and partners to the JLOS including other Government departments, the JLOS Development Partners, civil society organizations and the private sector that were contacted contributed significantly to the content of this Plan, and their input is acknowledged.

We are greatly indebted to the Nordic Consulting Group led by Ms Allen Sophia Asimwe for the support we received during the consultation and planning. Special thanks is made to the SIP II Task Force for the dedication and hard work in bringing together and analyzing various proposals received during the consultations to what is now the Plan.

SIP II Task Force

Ms. Evelyn B. Edroma	-	Senior Technical Advisor, JLOS (Chairperson, Task Force)
Mr. Sam Wairagala	-	Uganda Law Reform Commission
Mr. James Eceret	-	The Judiciary
Mr. Eli Muhumuza	-	Uganda Prisons Service
Ms. Rachael Odoi Musoke	-	Uganda Law Reform Commission
Mr. Jimmy Muyanja	-	Centre for Arbitration and Dispute Resolution
Mr. Timothy Halango	-	Uganda Police Force
Mr. Donal Cronin	-	The Irish Embassy
Ms. Dorothee Hutter	-	The German Technical Cooperation (GTZ)
Ms. Esther Loeffen	-	Royal Netherlands Embassy
Mr. Henry Nampandu	-	Technical Advisor, Commercial Justice Reform
Ms. Catherine Baine Omugisha	-	Technical Advisor, Criminal Justice Reform

PREFACE

The Justice Law and Order Sector (JLOS) is a reform process ongoing across the entire justice sector through a sector wide approach (SWAp) since 2000 to address the systemic weaknesses in the justice system that were compounded by lack of a clear policy framework for all the justice agencies to deliver quality justice efficiently and effectively. The sector maintained a long term perspective to the process of reform by adopting a Second Strategic Investment Plan (SIP II) in August 2006 for the period 2006/2007 to 2010/2011. The Plan, which incorporates prioritised and costed interventions, will enable the Sector to continue the reforms that were implemented under the first Strategic Investment Plan.

In developing the SIP II, the sector adopted a Government-led and participatory process. Consultations were held with all key stakeholders within and outside the Sector through a series of interviews, meetings, focus group discussions and workshops at regional and national level. The external stakeholders consulted included other sectors of Government, statutory bodies, civil society organizations, the private sector and development partners.

The SIP, II was built on the processes and lessons that the sector learnt during the implementation of its first Plan. In this sense, the SIP II consolidates and builds upon the first Plan by strengthening its strategies and addressing weaknesses identified during the Mid Term Evaluation. The sector also took into account the national framework within which the JLOS must feed into and contribute. The reason to continue the reforms were still based on the need to meet the set minimum standards in international human rights treaties that Uganda has ratified and the Constitution of the Republic of Uganda for an efficient and effective justice system. It was also premised on the recognition that a justice system ensures safety of the person and security of property, which are vital and necessary to provide an enabling environment for productive activity, investment and competitiveness; and hence poverty reduction and economic development.

The JLOS comprises ten institutions that discharge their mandates in an independent way. These mandates cover law and order aspects, as well as justice specific issues. The planning process for SIP, II considered the multi-dimensional and multi-institutional nature of justice for which consensus had to be built on common values and a common policy framework. To achieve this, a Task Force including the JLOS Secretariat and representatives of the JLOS Technical Committee, with the assistance of a consultant facilitated discussions and negotiations that resulted into ownership of the process and commitment to implement the reforms.

As a reform programme, the sector consultations and discussion aimed at identifying areas and strategies for reform over routine delivery of service. The challenge of a widened focus for the reform with limited human and financial resource required the sector to seek solutions in innovative and cost effective approaches to addresses the weaknesses in the system, and which would demonstrate results for the benefit of the people. The Plan provides the JLOS a unified policy and planning framework and strategy for reform to ensure that all the institutions operate in a coordinated

manner, using common approaches towards a shared goal under the leadership of the Ministry of Justice and Constitutional Affairs.

LIST OF ACRONYMS AND ABBREVIATIONS

ACRONYM	LONG FORM
AAI -U	Action Aid International - Uganda
ACTV	African Center for Torture Victims
ADR	Alternative Dispute Resolution
AG	Administrator General
AU/NEPAD	African Union/The New Partnership for Africa's Development
BFP	Budget Framework Paper
BoU	Bank of Uganda
CADER	Center for Arbitration and Dispute Resolution
CCAS	Judiciary's Court Case Administrative System
CCMC	Chain Linked Case Management Committee
CCUC	Commercial Court Users Committee
CID	Criminal Investigation Department
CMC	Case Backlog Committee
CMI	Chief Military Intelligence
CSOs	Civil Society Organisations
DDPR	Department of Disaster Preparedness and Refugees
DEI	Directorate of Ethics and Integrity
DPP	Directorate of Public Prosecutions
DRB	Domestic Relations Bill
DTG NARC	Donor Technical Group on Northern Uganda
EAC	East African Community
ECC	Executive Committee Courts (formerly Local Council Courts)
EU/ACP	European Union/African Caribbean Pacific
FHRI	Foundation for Human Rights Initiative
FMS	Financial Management Strategy
GoU	Government of Uganda
HIV/AIDS	Human Immune Deficiency Virus/Acquired Immune Deficiency Syndrome
IAF	Inter Agency Forum
IATC	Interagency Technical Committee (OPM)
ICT	Information Communication Technology
IDPs	Internally Displaced Persons
IEC	Information Education and Communication
IFMS	Integrated Financial Management System
IGG	Inspectorate General of Government
ILI	International Legal Institute
IMPC	Inter Agency Ministerial Committee (OPM)
ISO	Internal Security Organization
JCC	JLOS Coordination Committee
JLOS	Justice Law and Order Sector
J/DPG	JLOS Development Partners Group
KRA	Key Result Area

ACRONYM	LONG FORM
LABF	Legal Aid Basket Fund
LAC/LDC	Legal Aid Clinic/ Law Development Centre
LC	Leadership Committee
LCCs (ECCs)	Local Council Courts (now called Executive Committee Courts)
LDC	Law Development Centre
LOGICS	Local Government Information and Communication System
LSSP	Land Sector Strategic Plan
LTEF	Long Term Evaluation Framework
M&E	Monitoring & Evaluation
MAAIF, UIA	Ministry of Agriculture, Animal Industry and Fisheries
MDAs	Ministries, Departments and Agencies
MIA	Ministry of Internal Affairs
MoD	Ministry of Defence
MoES	Ministry of Education and Sports
MoFPED	Ministry of Finance, Planning and Economic Development
MoGLSD	Ministry of Gender Labor and Social Development
MoJCA	Ministry of Justice and Constitutional Affairs
MoLG	Ministry of Local Government
MoPS	Ministry of Public Service
MoWHC	Ministry of Works, Housing and Construction
MoWLE	Ministry of Water, Lands and Environment
MTCS	Medium Term Competitiveness Strategy
MTEF	Medium Term Evaluation Framework
MTTI	Ministry of Trade, Tourism and Investment
NCSP	National Community Service Program
NEMA	National Environment Management Authority
NIMES	National Integrated Monitoring and Evaluation System
NJF	National Justice Forum
NOTU	National Organization of Trade Unions
NSDS	National Service Delivery Survey
OPM	Office of the Prime Minister
PDG	Partners for Democracy and Governance Group
PAF	Poverty Action Fund
PAS	Paralegal Advisory Services Project
PEAP	Poverty Eradication Action Plan
PIRT	Presidential Investor Round Table
PLA	Platform for Labor Action
PMAU	Poverty Monitoring and Analysis Unit (MoFPED)
PPU	Policy Planning Unit
PPP	Private Public Partnerships
PR	Public Relations
PROCAM	Prosecution Case Management System
PRSC	Poverty Reduction Support Credit
PSCP II	Private Sector Competitiveness Strategy II
ROM	Results Oriented Management
SC	Steering Committee
SIP I	Sector Investment Plan I

ACRONYM	LONG FORM
SIP II	Sector Investment Plan II
SWAp	Sector Wide Approach
TAs	Technical Advisors
TAT	Tax Appeals Tribunal
TC	Technical Committee
TOR	Terms of Reference
UAC	Uganda Aids Commission
UBOS	Uganda Bureau of Statistics
UDHR	Universal Declaration of Human Rights
UDN	Uganda Debt Network
UEPB	Uganda Export Promotion Board
UGANET	Uganda Network on Law and Ethics
UHRC	Uganda Human Rights Commission
UIA	Uganda Investment Authority
ULA	Uganda Land Alliance
ULAA	Uganda Local Authorities Association
ULGA	Uganda Local Governments Association
ULRC	Uganda Law Reform Commission
UNCDF	United Nations Capital Development Fund
URA	Uganda Revenue Authority
URSB	Uganda Registration Services Bureau
UWEAL	Uganda Women Entrepreneurs Association Limited
WG	Working Group
WTO	World Trade Organisation

LIST OF TABLES, FIGURES AND BOXES:

TABLES:	PAGE
TABLE 1: CASE LOAD IN COURTS OF JUDICATURE, 2005	16
TABLE 2: COURT PERFORMANCE/ WORK, JULY- OCTOBER 2005	17
TABLE 3: KEY CROSS CUTTING ISSUES TO BE MAINSTREAMED IN SIP II	35
TABLE 4: INTERSECTORAL LINKAGES AND COLLABORATION	37
TABLE 5: M&E RESPONSIBILITIES IN THE VARIOUS STRUCTURES	54
TABLE 6: ITEMISED NATIONAL BUDGET	
TABLE 7: PROVISIONAL SECTOR SHARES OF BUDGET	56
TABLE 8: JLOS RESOURCE ENVELOPE	57
TABLE 9: JLOS SIP II FUNDING GAP	59
TABLE 10: FUNDING BY YEARS IN SIP II	59
TABLE 11: JLOS SIP II BUDGET BY KRA BY FY	63
TABLE 12: JLOS SIP II FUNDING SOURCES	63
TABLE 13: MTEF INDICATIVE FIGURES 2006/07	64
TABLE 14: SUMMARY BUDGET IN THE MEDIUM TERM PER KEY RESULT AREA	64

FIGURES:

FIGURE 1: POVERTY DISTRIBUTION MAP OF UGANDA	4
FIGURE 2: CRIME TRENDS IN THE PAST 10 YEARS	12
FIGURE 3: JLOS STRUCTURES AND MANAGEMENT INFORMATION FLOW	49

BOXES:

BOX 1: KEY ACHIEVEMENTS IN JLOS DEVELOPMENT PROGRAMME	10
BOX 2: BROAD SECTORAL CHALLENGES	15
BOX2: KEY PRINCIPLES UNDERPINNING SIP II	19

SECTION II: EXECUTIVE SUMMARY

EXECUTIVE SUMMARY:

The Justice Law and Order Sector Second Strategic Investment Plan (JLOS SIP II) consolidates progress and builds upon processes undertaken in the first JLOS Strategic Investment Plan that was launched in November 2001. JLOS SIP II bears a heightened focus on the poor and marginalised groups, a direction arising from the Sector's obligation to demonstrate results to the general public to whom it is ultimately accountable. Successful implementation of this SIP II will translate into improved institutional service delivery, human rights observance, enhanced access to justice for all and poverty reduction in all areas in Uganda including the conflict affected regions. The Sector deems it critical to its growth to maintain the performance momentum from SIP I - premised on continued institutional engagement while at the same time fostering novel human rights based initiatives.

i) JLOS Reform Priorities in the Medium term;

The Justice Law and Order Sector (JLOS) strategic plan anchors its investment in Pillars 2, 3 and 4 of the Poverty Eradication Action Plan (PEAP), which is the overarching framework for Uganda's growth and development. Uganda needs to enhance its ability to create wealth in order to alleviate poverty and increase the incomes of its people by enhancing competitiveness through increased productivity. The PEAP and its supporting strategies, the Plan for Modernization of Agriculture (PMA), the Strategic Exports Programme (SEP) and the Medium Term Competitiveness Strategy (MTCS) were designed to increase competitiveness by supporting and sustaining the productivity of the economy through increases in the efficient production of goods and services so that they can fetch higher value in the domestic regional and global markets.

Globally, crime ranks with corruption and uncertainty of policy and judicial behaviour as one of the serious problems that increase the cost of doing business in a country and aggravates levels of poverty. In the wake of lawlessness and inadequate protection from theft, violence and other acts of predation, markets cannot develop and property rights are least effective. Similarly, land and family justice have been highlighted as key issues of concern especially for poor and marginalised persons. Land disputes rank among the highest countrywide and are often the cause of other disputes including family and domestic violence, assaults and murder.

The Sector also recognizes that the peoples' needs and aspirations of the justice system are closely intertwined with their livelihood opportunities. Obtaining a speedy and fair remedy in a land dispute, a safe and value-free forum to be heard in a domestic violence case, being informed and consulted as a victim in a criminal case, and settlement of contractual disputes all happen in people's daily lives.

It is the role of the JLOS to protect and promote these human rights and in the medium term. The JLOS will therefore focus on enhancing access to justice in four focus areas of Commercial, Land, Family and Criminal Justice. Interventions within the current SIP are aimed at "*consolidating gains from SIP I and enhancing impact through SIP II*".

Reforms in the JLOS have a direct bearing on improvements in the micro economic environment in which businesses operate and have a positive and indirect

contribution to make to the growth of other key sectors of the economy such as Agriculture, industry/manufacturing, services and tourism.

ii) Key Principles underpinning SIP II:

The principles take into account achievements and lessons from SIP I and anticipate the emergence of new challenges and threats over the course of SIP II. They emphasize enhancing quality of justice and impact to the beneficiaries; as well as confidence of users through improved service delivery and accountability. Innovative approaches and low cost solutions are to be utilised to enhance JLOS capacity to directly address impact of its reforms on human rights for citizens within limited resources. In addition, identified priorities have a direct contribution to economic development and wealth creation and providing minimum levels of justice delivery countrywide especially in the remote and conflict affected areas of Uganda.

Key challenges include the slow legislative process, inadequate financial and human resource, slow disposal of cases and services, limited awareness and appreciation of JLOS reforms (both internally- Staff and externally- Public and Users). **In response**, the SIP II underlines:

- Legislative reform
- Reduction of case backlog
- Faster disposal of cases and matters
- Improved processes so as to minimise the cost of doing business
- Reduction of crime prevalence
- Reduction in the remand period
- Reduction of specific human rights violations
- Improved service delivery in conflict affected areas
- Rehabilitation of offenders and diversion of juveniles from the justice system
- Enhancing legal and civic awareness
- Integration of cross-cutting issues such as Gender, HIV/ AIDS
- Strengthening of JLOS institutions, intra sectoral and inter sectoral linkages

iii) JLOS SIP II Policy and Planning Framework:

The **mission** of the JLOS is *to ensure all people in Uganda live in a safe and just society*. The **overall goal** of the sector is *to enhance the quality of life and ensure that poverty in Uganda is eliminated*. The **JLOS purpose** is *to improve the safety of the person, security of property and access to justice in order to encourage economic development and benefit poor and vulnerable people*. The **brand name** is JLOS *Justice for All*.

Five **Key Result Areas** (KRAs) have been identified to achieve this purpose and include:

- O.1 Rule of Law and Due Process Promoted
- O.2 Human Rights Culture fostered across JLOS institutions
- O.3 Access to Justice enhanced for all particularly the poor and marginalised
- O.4 Incidence of Crime reduced and Safety of the Person and Security of Property promoted
- O.5 JLOS contribution to economic development enhanced

The overlap and intersection within the result areas strengthens the reform programme and enables demonstration of impact.

Building on lessons from SIP I, SIP, II enhances efficiency and effectiveness in the management structure and processes with the recognition that a strengthened JLOS Secretariat is pivotal to the reform process. The key result areas and related activities are linked to a Monitoring and Evaluation (M&E) framework with baseline indicators and targeted outcomes. Although JLOS still has to work within a limited resource envelope, its marginal share of the general budget has increased. The sector's overall budget in the next three years stands at U.shs.600.3bn consisting of recurrent, development and capital expenditure, averaging 4.87% of the national budget. The SIP, II programs cover the development activities amounting to U.shs.68.4bn over the three years. Improvements in financial management are anticipated from implementation of the Financial Management Strategy.

Like any reform process, successful implementation of SIP II requires an engaged, motivated and accountable staff force as well as effective engagement of all stakeholders. In the course of SIP II implementation the sector wide process will continuously foster closer engagement and ownership, including positive management of institutional change. Process enhancement initiatives will have the following key actions:

- Raise consciousness and change of attitudes within JLOS institutions to appreciate sector wide approaches, and assume full ownership of Sectoral outcomes.
- Build and strengthen working relationships and involvement of civil society, local administration and private sector in the reform process
- Support users of the justice system in demanding better and improved services as a result of continued public investment in the Sector.

iv) SIP II Planning Process

SIP II has built on the processes and lessons learnt from SIP I and in this sense forms continuity to the reform process. In developing SIP II, a highly participatory process was undertaken with all key stakeholders through a series of interviews, meetings, focus group discussions and workshops. To facilitate this process was the Nordic Consulting Group (U) Ltd working closely with the JLOS Governing structures, the Secretariat, SIP II Formulation Task Force and all key stakeholders including civil society organisations (CSOs) and the private sector.

v) Structure of SIP II:

The SIP II is arranged in two broad parts – the main body and the annexes. The main body of SIP II has six sections.

Sections I and II comprise the Foreword, Preface and Executive summary respectively. Sections III to V contain 8 chapters capturing the build up of SIP II.

Section III lays the foundation which introduces the sector and reflects on SIP I. In this section, Chapter 1 provides the overall legal and policy framework while Chapter 2 reflects on SIP I and introduces the direction of SIP II.

Section IV elaborates on the reform process and here Chapter 3 provides an in-depth discussion of the priority areas, while Chapter 4 highlights the key strategies and approach.

Section V focuses on management of the reform process. In here, Chapter 5 lays out the key management structures and processes while Chapter 6 outlines the monitoring and evaluation framework. Chapter 7 is an analysis and presentation of the re-sourcing within the Sector and Chapter 8 highlights some key transitional arrangements from SIP I to SIP II.

Section VI is also Part 2 of SIP II comprising annexes and key process documents.

**SECTION III: INTRODUCING THE SECTOR AND
REFLECTING ON SIP I**

CHAPTER 1: LEGAL, POLICY AND OPERATIONAL FRAMEWORK

1.1 Introduction

Following almost two decades (1966-1986) of political, civil and economic regress in Uganda, there was an extensive breakdown of functions of the state including the maintenance of law and order. Governments then failed to provide the requisite infrastructure, logistics, personnel, legal and policy direction to legitimate state institutions to effectively execute their mandate. This period was characterised by:

- chronic systemic constraints that delayed and hampered access to justice and service delivery, effective planning and budgeting,
- antiquated methods and tools of investigation and prosecution,
- the high cost of justice due to corrupt practices and limited proximity to the justice delivery agencies by end-users,
- case backlogs and high prison populations,
- inefficiencies and lack of effective procedural guidelines and performance standards in justice delivery institutions as well as
- Significant gender-based discrimination.

1.2 International and Regional Treaty Obligations

During the two decades following 1986, Uganda became party to, and strives to uphold major international and regional human rights treaties and initiatives that define standards for service delivery through an effective system of justice, law and order. These include:

- International Covenant on Civil and Political Rights, 1966.
- International Covenant on Economic, Social and Cultural Rights, 1966.
- UN Convention against Torture, Cruel, Inhuman and degrading Treatment or Punishment, 1984.
- UN Convention on the Elimination of All Forms of Discrimination Against Women, 1979.
- UN Convention on the Rights of the Child, 1986
- African Charter on Human and People's Rights, 1981.
- New Partnership for African Development (NEPAD).
- East African Community Treaty 1999 and related instruments.

The Constitution of the Republic of Uganda 1995¹ too provides a strong basis for reforms. Institution-focused initiatives that followed the enactment of the 1995 Constitution culminated into a sector-wide approach, which is a means of organising with a particular focus on policy and institutional coherence in service delivery. Thus in 2001, the Government of Uganda (GoU), with support from several development partners formally embarked on a programme to reform the Justice, Law and Order Sector (JLOS) based on a Strategic Investment Plan (SIP) 2000/01 - 2005/06, (SIP I).

¹ This was reviewed in 2004/5 by a Constitutional Review Commission and a Constitutional Amendment Bill 2004 has since been debated.

1.3 Sector Set-up and Stakeholders

1.3.1 The membership of JLOS in SIP 1 of the following 10 institutions has been maintained as core institutions directly involved in the administration of justice and maintenance of law and order:

- Ministry of Justice and Constitutional Affairs (MoJCA) including Uganda Registration Services Bureau until attainment of its full autonomy and Administrator General's Department
- Ministry of Internal Affairs (MIA) including Immigration, National Community Service Programs and the Government Analytical Laboratory
- The Judiciary including the Commercial Court
- The Uganda Prison Service (UPS)
- The Uganda Police Force (UPF)
- The Directorate of Public Prosecutions (DPP)
- The Judicial Services Commission (JSC)
- The Uganda Law Reform Commission (ULRC)
- Ministry of Gender, Labour and Social Development - Probation Services (MoGLSD)
- Ministry of Local Government - Local Council Courts (MoLG)

In order to implement its SIP II, JLOS will liaise with stakeholders including CSOs, the Private Sector, Local Government and other sectors, government ministries and semi-autonomous bodies and initiatives. The definition of stakeholders is based on their direct and indirect relevance and/or involvement in JLOS operations. The end-users of JLOS constitute the ultimate beneficiaries and therefore stakeholders in SIP II. Their involvement is ensured through various SIP mechanisms as indicated in Chapter 4.

1.4 Management and Co-ordination mechanisms

The Sector management structure is reflected at two levels - national and local level (districts and below). The structure is based on a committee and working group arrangement that ensures participation and coordination of JLOS members, stakeholders and partners at both levels. The entire management structure is facilitated by the Sector Secretariat and is laid out in Chapter 5.

JLOS also works in partnership with Development partners under the JLOS Development Partners Group. (See Chapter 5 -Management structure and processes).

1.5 Socio-economic context

The socio-economic context in which JLOS is to implement SIP II is clearly articulated in the Poverty Eradication Action Plan (PEAP) 2004/05 - 2007/08, the GoU framework for the planning and execution of development interventions. The PEAP indicates poverty, conflict and internal displacement of people, as well as HIV/AIDS among the contextual issues posing serious challenges to all sectors of Uganda's economy. Other aspects of the socio-economic context include gender-based discrimination and corruption. The return to a multi-party system of

governance will inevitably draw on JLOS resources to ensure stability at household, community and national levels.

1.5.1 Poverty: The proportion of people living below the poverty line in Uganda rose from 34% in 2000 to 38% in 2003. The PEAP 2004 categorises the poor and marginalized to include juveniles, women, people in conflict affected or remote areas, HIV/AIDS patients.

Figure 1: Poverty Distribution Map of Uganda

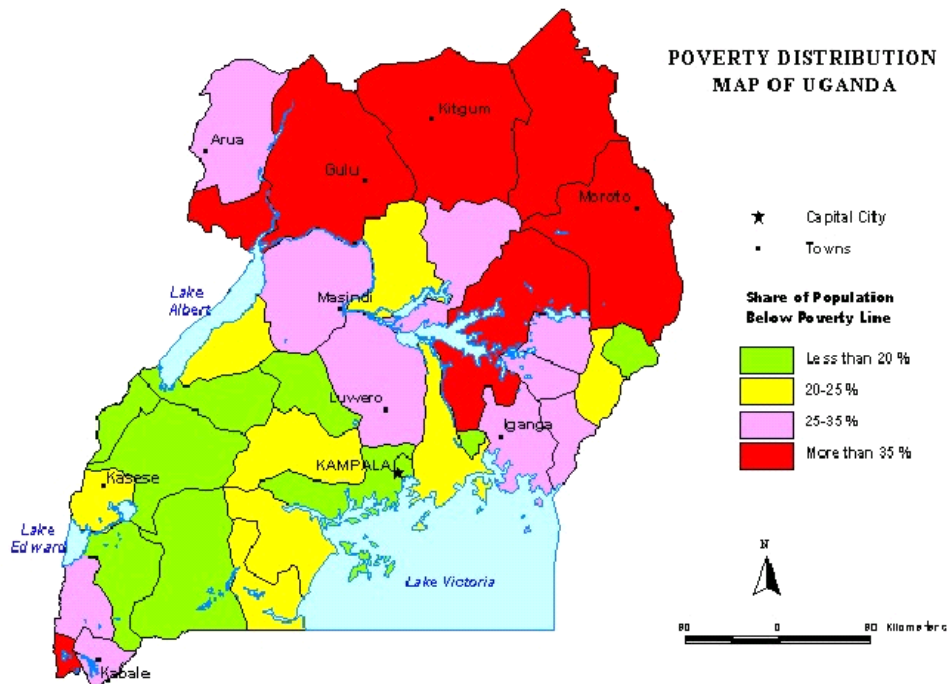

Source: Economic Commission for Africa, 2003

The poverty status of Ugandans at an individual and collective level raises the following implications for access to justice and economic development:

- Poverty dis-empowers individuals and groups of people and increases inequality in various aspects of life. This diminishes the initiative of the poor to pursue their rights.
- Crime can be magnified in the poorer communities due to the marginalisation and poverty faced. However white collar crime also occurs without poverty being present and is often less visible and undetected.
- the cost of pursuing justice is not affordable by the poor
- the poor have a high propensity to commit crime
- Poor families increase the incidence of juvenile delinquency. Juvenile delinquents constitute a large percentage of petty offenders with the likelihood of growing into hardened criminals

1.5.2 Conflict and internal displacement of persons: In Uganda 18 districts falling within 3 major regions of Acholi land, Karamoja and Teso have been affected by conflict. The PEAP indicates that nationally, 5% of the population are internally displaced with the attendant effects of increased poverty and HIV infection rates. In addressing itself to the questions of access to justice in conflict affected areas and for internally displaced persons, the implementation of SIP II is faced with the following realities:

- Breakdown of civil administration of justice creates volatile communities. This increases insecurity of persons and their property, and raises incidence of crime such as escalation of rape of women and girls, domestic violence and murder.
- Temporary replacement of civil administration of justice with military arrangements has often compromised the quality of justice.
- The need to balance the relationship between traditional and formal justice systems, where the former are not always rights-respecting and the latter is weakly institutionalized.
- The destruction of property and displacement of persons increases land disputes and issues of compensation
- how to reconcile between accountability and the quest for immediate and tangible 'perceptions' of justice without jeopardizing long-term structural reform plans

1.5.3 HIV/AIDS: Uganda is among the countries hardest hit by the AIDS pandemic. The prevalence rate of HIV/AIDS is currently at 6% nationally with a marked reduction in new transmissions.² The challenges posed by the HIV/AIDS pandemic affect the sector at two levels; internally for its staff and persons in conflict with the law such as prison inmates, and externally in relation to the public as prospective users of the justice delivery system. Implications for the implementation of SIP II include:

- the effect of HIV/AIDS on the sustenance and productivity of the labour force in JLOS institutions
- social stigma leading to discrimination in various spheres of life including education, employment and in the pursuit of justice particularly for widows and orphans.
- the need to ensure access to the necessary health services and freedom from discrimination for prison inmates (men, women and juveniles).
- delays in the Administrator General's Office and implications for the rights of families affected by HIV/AIDS.
- implications of HIV/AIDS on the law of sexual offences.

1.5.4 Gender Inequality: Uganda being a patriarchal society presents various challenges for equality of the sexes. A JLOS study on Gender and access to Justice (2001) revealed that gender related barriers in accessing justice occur at different levels of substantive laws, the administration of law and the community where disputes occur. These barriers are interlinked and should

² PEAP 2004/5-2007/8

be responded to comprehensively. The study further established that whereas there are factors that affect access to justice for both men and women, the structural gender inequalities and biases that permeate all levels of society invariably aggravate and in some cases increase the hurdles that women must overcome in order to access justice. The implementation of SIP II must therefore address the gender-based challenges of accessing justice within substantive laws, the administration of justice and the community level.

1.5.5 Corruption: Despite Government of Uganda's (GoU) array of policy formulations and technical achievements, several studies including the 2003 National Integrity Survey reports indicate that the perception of corruption and real level of corruption in public offices in Uganda is still high. This undermines GoU efforts to promote good governance and fight poverty. The most common types of corruption complained about in public office include non-payment of salaries, delay in service delivery, mismanagement and misappropriation of public resources and abuse of office.³ JLOS has a crucial responsibility in the fight against corruption to ensure that the problem is stemmed within justice delivery agencies, and to prosecute and punish perpetrators so that it does not continue with impunity.

1.5.6 Multi party democracy: After a quarter of a century, the year 2006 marks Uganda's return to a multi-party system of governance. The period of implementation of the JLOS SIP II therefore coincides with the first term of a government run on the basis of multi-party politics. It follows that as the country strives to enhance democratic governance, a strong JLOS is a prerequisite to ensure protection of human rights and fundamental freedoms for all persons, whether as contestants, as voters or as non-voting citizens and residents.

1.5.7 Commonwealth Summit 2007: The planned hosting of the Commonwealth Summit in 2007 provides an opportunity for GoU to further build on its efforts towards a positive international image. There will be issues to address in the period preceding, during and after the Summit that JLOS will be required to address. These include ensuring law and order, safety and security, and press freedom.

1.6 National Policy framework

1.6.1 Poverty Eradication Action Plan (PEAP): Uganda subscribes to the Millennium Development Goals (MDGs) which include 8 goals, 18 targets and more than 40 indicators⁴, which are monitored on a global scale with the aim of reducing poverty and showing quantitative results by 2015. Although Uganda's original PEAP 1997 predates the Millennium Declaration, the current revised PEAP December 2004 reflects Uganda's efforts towards achievement of the MDGs.

³ IG Report to Parliament 2002

⁴ www.un.org/millenniumgoals See also Annex 1 for an overview.

The PEAP is anchored on 5 pillars, however the JLOS operations are most critical to:

- Pillar 2:** Enhancing production, competitiveness and incomes,
Pillar 3: Security, conflict resolution and Disaster management,
Pillar 4: Good Governance (including democratization, and Justice, law and Order, among others)

1.6.2 *The Constitution of the Republic of Uganda, 1995:* The Constitution, 1995 clearly embodies human rights freedoms, principles of rule of law, good governance and due process as enshrined in the major human rights treaties. The Constitution further articulates the principles upon which the GoU shall construct the mechanism for governance and improved personal safety, security and access to justice. The national objectives and directive principles of state policy as stated in the Constitution include comprehensive commitments to guarantee and respect institutions which are charged by the State with the responsibility for protecting and promoting human rights, empowerment of marginalized and vulnerable groups and ensuring accountability among others.⁵

The rights and freedoms enshrined in Chapter Four of the Constitution shall be respected, upheld and promoted by all organs and agencies of Government and by all persons⁶. These rights and freedoms include:

- Equality and freedom from discrimination based on, *inter alia*, sex, race, colour, ethnic origin or social economic standing⁷;
- Equality of all persons before and under the law, and that no person shall be deprived of personal liberty except, *inter alia*, in the execution of a sentence or an order of the court⁸;
- Upon deprivation of personal liberty all persons shall be restricted or detained in a place authorised by the law and informed immediately of the reasons for arrest and the right to a lawyer. In the case of capital offences, the State shall provide legal representation to the indigent at the State's cost⁹;
- All persons arrested or detained are entitled to apply for bail. There shall be a limitation period for detention for those not convicted of any offence and while incarcerated persons shall not be subjected to inhumane or degrading treatment or punishment¹⁰.
- Women shall be accorded full and equal dignity of the person with men. The state shall protect women and their rights, taking into account their

⁵ Constitution of the Republic of Uganda 1995. National Objectives & Directive Principles of State Policy

⁶ Ibid Article 20(2)

⁷ Ibid Article 21(2)

⁸ Ibid Article 21(1) & 22 (1) & 23(1) & 28(3)(e)

⁹ Ibid Article 23(2), (3) & 23(6)

¹⁰ Ibid Article 23(6)(a-c) & 24

unique status and natural maternal functions in society. Law, cultures, customs or traditions which are against the dignity, welfare or interest of women or which undermine their status, are prohibited.¹¹

- “In the determination of civil rights and obligations or any criminal charge, a person shall be entitled to a fair and speedy public hearing before an independent and impartial court or tribunal established by law.”¹²

Chapter Four also allows Parliament to enact laws necessary to implement policies and programmes aimed at redressing social, economic or educational or other imbalance in society, and laws that provide for any matter acceptable and demonstrably justified in a free and democratic society.¹³

It is upon these principles, policy objectives and inherent rights and freedoms that the JLOS seeks to anchor the reforms within the SIP II.

1.7 JLOS as part of Ongoing National Reforms

The successful implementation of ongoing national initiatives that have a direct bearing on the JLOS SIP II was crucial in the planning period. JLOS SIP II will therefore undertake collaborative action with implementing institutions to ensure information exchange and learning that supports the attainment of the JLOS objectives. Priority will be given to the following ongoing national initiatives:

- Pay reform/Human Resource Development and Results Oriented Management under the Ministry of Public Service
- Poverty Reduction Strategies including the Rural Development Strategy, Poverty Monitoring and Analysis and the Integrated Financial Management System (IFMS) under the Ministry of Finance, Planning and Economic Development
- Development of ICT policies and strategies for all Government ministries and agencies and the National Integrated Monitoring and Evaluation System (NIMES) under the Office of the Prime Minister
- Government Policy on Build Own Operate and Transfer (BOOT) aimed at reducing costs of renting and encouraging institutions to build offices

1.8 JLOS Policy framework

The JLOS policy framework is anchored in key international, regional and national legal and policy frameworks aimed at fostering human rights and enhancing access to justice, Over SIP I, eight key policy objectives underlined policy developments in JLOS and these objectives have been reviewed and revised to arrive at 5 objectives underpinning SIP II (*as laid out in chapter 3*).

¹¹ Ibid Article 33(1), (3), (6)

¹² Ibid Article 28(1)

¹³ Ibid, Article 21(4)(a) &(c)

CHAPTER 2: A REFLECTION ON SIP I

2.1 Understanding the Reform Process

- 2.1.1 The Justice, Law and Order Sector reform process has as its backdrop increased coordination and cooperation aimed at enhancing coherence in policy discussion and resource allocation. This mode of organization, though unprecedented in Africa at the time of its launch in Uganda in 1999, is steadily taking root all over Africa. Uganda's immediate neighbours of Kenya and Tanzania are presently implementing their initial Strategic Investment Plans, a development that will present opportunities for cross border learning and adaptation of appropriate practices to JLOS. Common to all countries that have embraced sector wide approaches (Swap) is its engaging and ongoing process of programme management premised in the context of limited sectoral human and financial resources.
- 2.1.2 Uganda's adaptation to the sector wide model has been an involving and consistently forward looking process. It has not been the first attempt at reform either. A chronological review of reforms in the administration of justice reveals that the sector wide approach was preceded by institutional reforms utilising donor project support and in-depth assessments for instance the Commission of Inquiry into Judicial Reform, 1995, the Crown Agents Review of Uganda's Criminal Justice System of 1997 with its World Bank follow up and the 1999 Uganda Commercial Justice Study. These have all been precursors of the Justice, Law and Order Sector reforms.
- 2.1.3 The Sector wide approach stretches back to 1999 following a policy decision taken at the Mamba Point meeting to constitute a Sector in the administration of justice. Today, JLOS is distinctly defined, operates within a sectoral policy framework, enjoys solid relationships with development partners guided by jointly agreed Partnership Principles and has its resource allocations guided by sectoral and national priorities. Over the last five years, the JLOS development budget has not only increased quantitatively but is partly protected under the Poverty Action Fund demonstrating increased confidence in the Sector by development partners and at the national level¹⁴. To prepare for the implementation of SIP II it is instructive to reflect upon and draw lessons from the SIP I design and implementation experience.

2.2 Respecting the Past: Learning from SIP I

- 2.2.1 The Justice, Law and Order Sector at the outset identified two core areas of reform i.e. Commercial and Criminal justice. Under SIP I, the Criminal Justice Reform Programme was clustered around the following themes:
1. Legal Services aimed at sustaining accountability, efficiency and equity of access across the Justice system

¹⁴ The components of the JLOS Development Fund that have been protected include the SWAP Development Fund, Commercial Justice Reform Programme Fund and Case Backlog Reduction Programme

2. Strengthened Administration of Justice
3. Promotion of Civic and Legal Education
4. Criminal Law Reform

The second priority area for reform packaged under the Commercial Justice Reform Programme was structured along the following themes;

1. Commercial Court Reform
2. Companies and Land Registry Reform
3. Commercial Law Reform
4. Capacity building for Commercial Lawyers

2.3 Achievements and Lessons Learnt under SIP I

2.3.1 Process as a Crucial Factor in Sector Development

Development of a sector to enhance efficiency and effectiveness is a process that can only be progressively undertaken by the institutions themselves. External partners can provide the resources and facilitate the process but cannot deliver the desired outcome. It is thus noteworthy that the Government of Uganda can point to the following process gains from SIP I;

- Government of Uganda took responsibility for the Justice, Law and Order Sector policy and implementation plan.
- Presence of political will to resource and implement the Plan.
- Adoption of a long term perspective to the process of reform.
- Developed partnerships between development partners, civil society organizations and Government of Uganda.
- Consistent development partner shift from project support to sectoral support.

2.3.2 Implementation of SIP I: Achievements and Challenges

a) The JLOS Mid-term Evaluation points to the following achievements in SIP I implementation;

Box 1: Key Achievements in JLOS Development Programme

- Reduction in length of stay on remand from an average of 24months to less than 15 months for serious offences
- Reduction in the number of persons held on remand beyond the constitutional period from 39% to 1% and 23% to 10% for serious and petty offences respectively.
- Increased efficiency in the Commercial Court as evidenced in case throughput and application of alternative dispute resolution mechanisms,
- Establishment of CADER and TAT,
- Reform of 40 commercial laws and integration of regulatory best practices in policy formulation and practice (Note: Laws are at different levels in the legislative process)
- Enhanced capacity of the legal profession in commercial disputes including establishment of a functional Legal Resource Center at the Uganda Law Society.

The Mid-Term Evaluation also pointed to several challenges for the Sector some of which are highlighted below:

- Financial constraints: increasing JLOS share of the national budget, attaining a close match between sector allocations and actual releases; rationalisation of resources within the Sector and generation of efficiency savings within the Sector.
- Management: the need to build adequate policy, managerial and operational capacity and integrity; premised in functional organizational systems, and delayed implementation of a financial management Strategy.
- Programmatic: Achieving clarity in output targets and demonstrating their contribution to the national and sectoral objectives, an increasing demand for justice services in line with the pacification of conflict affected areas, an increasing national population and heightened levels of legal and civic awareness.
- Monitoring and evaluation: Development of a national-local level feedback system with baseline indicators, adequate staff capacity, consolidating and institutionalisation of data sources, and strengthening performance measurement and reporting systems.
- Increased sector cohesion, accountability and team building present focal areas of concentration for SIP II. Strengthening the sector wide process will constitute a core component of SIP II under the broad themes of strengthening sector wide management and strengthening the alignment of sector wide processes and actors towards the SIP II policy objectives.

2.4 Ongoing work to Constitute Part of SIP II:

A number of ongoing initiatives aimed at addressing some of the above challenges have been undertaken and will be reviewed, adopted and rolled over into SIP II and include:

- **Ongoing studies in** Commercial and Criminal justice including the Court Awards and Compensations Study, Study on Small Claims Court,
- **Ongoing pilots** including the Case Backlog Reduction Project, the CADER Mediation Pilot Project, Prisons Farms Pilot and the Uganda Police Vehicle Fleet Management Systems. (Note that these will be evaluated in the transition phase).
- **Expanding Programmes** which have emerged from Pilot initiatives, including National Community Service Programme, and Chain-Linked Initiative.
- **Annual recruitment of Staff** including the recruitment of 500 Police and 500 prisons warders, and the recruitment of up to 4,000 auxiliary forces into the Police and redeployment in conflict affected areas
- **Construction of offices** e.g. the Commercial Court, other courts up country, and regional offices,
- **Law reforms** e.g. the Police Act passed at the end of 2005, revision of Civil and Criminal Procedures

2.5 Towards SIP II: Expanding the Scope

Beyond Commercial and Criminal Justice, JLOS expands its focus to two additional areas of reform. Focus areas for SIP II therefore include;

- (a) Criminal Justice
- (b) Commercial Justice
- (c) Land Justice
- (d) Family Justice

2.5.1 Criminal Justice

Safety requirements and the well being of the people are indivisible. The inability to protect one self and one’s valuables from the whims of others and the feeling of vulnerability that comes with it are fundamental counters to the concept of safety and personal well being. It is for this reason that crime and safety requirements continue to be a focus area for reform in SIP II.

As a result of the implementation of the reform activities in the first Strategic Investment Plan some notable improvements have been realised in the criminal Justice System. However, the criminal justice context continues to be shaped by increasing reported crime levels, increase in crime spread and sophistication. Of equal concern is the development of new crime patterns such as trans-national organised crime, IT based crime, terrorism, money laundering and crimes arising out of increased proliferation of small arms and light weapons. External to the Justice, Law and Order Sector, conflict and economic downturns breed crime among the population in levels that can barely be matched by law enforcement agencies.

Within the Criminal Justice System, effective detection, investigation, prosecution and adjudication of crime and criminals shape institutional operations largely deriving from systemic inadequacies including inadequate legislation, institutional resources that constrain capacity and attitudinal barriers to change. Largely the Ugandan situation is characterised by the following challenges which form the basis for SIP II programmes in this area:

- i. High levels of crime- Fig 2 shows crime trend in the past 10 years

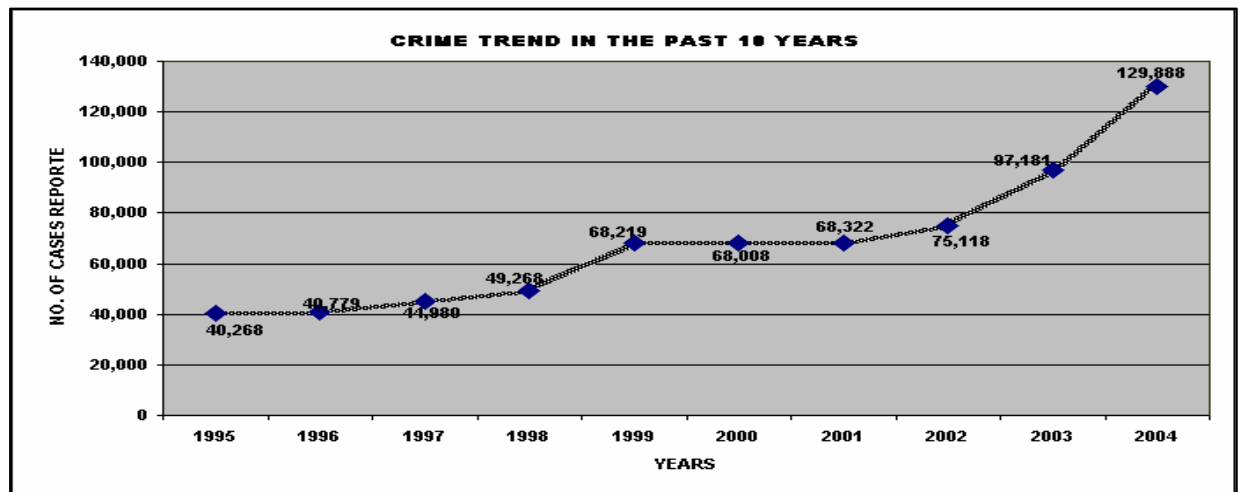

Source: JLOS Progress Report, June -November 2005

- ii. Borders that are vulnerable to illegal immigration, trans-border crime and global terrorism
- iii. A caseload of 50,590 criminal cases filed in Court in 2004, 47,578 criminal cases in 2005 matched with a disposal rate that declined from 30% in 2004 to 21% in 2005.
- iv. An increasing remand population partly as a result of (c) above but also as part of undue criminalisation of social behaviour and
- v. Low levels of human rights observance amongst JLOS institutions with JLOS officials comprising 399 of the total 1956 respondents accused of human rights violations and 31% of torture cases (as per the 7th Annual Report, UHRC).

2.5.2 Family Justice

JLOS takes particular note of the profound effect of the legislative framework and family justice mechanisms on all social structures and particularly the family. SIP II therefore accords priority to family justice as a focus area for reform in the medium term in accordance with the constitutional provisions that give due protection to the family.

At the international level, Uganda ranks high in the prevalence of domestic violence. The delay in passing the law of domestic relations, absence of a national policy on domestic violence, a weak legislative framework and a slow disposal rate of family causes renders considerable injustice to the claimants particularly women. By November 2005, a total number of 1645 family causes remained pending with a total of 1043 cases registered while the Administrator General had a caseload of 2372 pending cases with a total of 1616 registered cases.

By prioritizing the reform of Family Justice, the Sector will seek to reverse the present position which is characterised by:

- i. Paucity of information on the state of family justice in Uganda.
- ii. Growing caseload in the administration of estates unmatched by staffing and resource allocations.
- iii. Inadequate legislative provision to address gender based violence and equality of rights at marriage, during marriage and at its dissolution.
- iv. Inadequate equipment and staffing at all levels in key institutions of Probation, Family and Children's courts, Administrator General and Family and Child Protection Police Units.
- v. Centralized service delivery in the Administration of estates that puts additional burdens on the poor and rural based who most need their services
- vi. Low levels of coordination among family based agencies
- vii. Low levels of public awareness of legal provisions, procedures and modes of access to services
- viii. Reform of old fashioned and gender imbalanced laws, and the lack of harmonised family laws that are aligned to constitutional guarantees.

2.5.3 Commercial Justice

The Commercial Justice Reform Programme (CJRP) was designed to address key challenges in access to commercial justice including: rampant delays and a huge case

backlog, corruption, inefficiencies in the justice system and lack of commercial awareness in the courts and the public. All these contributed to the increasing the cost of doing business in Uganda. Reforms were thus geared towards: reforming key institutions including the Commercial Court, the Land and Company Registries, reforming key commercial laws and strengthening capacity of commercial lawyers.

Under the Mid Term Evaluation, key achievements were registered as indicated in Box 1. However key challenges that persist and which SIP II will continue to address include:

- i. The lack of harmonised indicators between CJRP institutions and other JLOS institutions.
- ii. Limitations within Commercial Justice Reforms to respond to gender, poverty and HIV AIDS issues.
- iii. Lack of premises that led to the shifting of almost all the institutions during SIP1 leading to disruption of reforms and additional costs.
- iv. The failure to fully integrate the land registry under the CJRP and the delay in devolving of the Business Registry into the URSB led to setbacks in implementing much needed reforms.
- v. Inadequate funding and delayed disbursement of funds. In some cases lack of allocation of votes directly from the consolidated fund led to set back in achieving the required targets and this was exacerbated by inadequate human resource capacity and high turn over.
- vi. Centralisation of reforms in and around Kampala with limited geographical outreach
- vii. The need for small claims courts/ and fast tracking procedures. The pecuniary jurisdiction of the commercial court and the complicated administrative requirements/ processes of the business registry are still not amenable to micro, small and medium enterprises (SME's).
- viii. Inadequate use of Alternative Dispute Resolution mechanisms
- ix. Lack of strategic public/public and private/public partnerships mirroring the Commercial Court Users' Committee to encourage meaningful involvement of the private sector/civil society into JLOS activities
- x. Slow responses and adapting to reforms due to mindset and attitudinal problems within restructured commercial justice institutions

2.5.4 Land Justice:

Access to land and land rights are enshrined under the Constitution of Uganda 1995 and the Land Act 1997 (as amended). Under Pillar 2 of the PEAP on Enhancing Productivity and Competitiveness, the focus of Land reforms is geared to clarifying land rights and strengthening rights of the poor. Ongoing GoU programmes this end fall under the Ministry of Land, Water and Environment and are captured under the Land Sector Strategic Plan (LSSP) 2001- 2010. The LSSP focuses on protection of land rights of the poor, improved access to land and tenure security. Under the LSSP, the World Bank is to channel support through the Private Sector Competitiveness programme II to the Land Registry for reform of titling. The key challenges to land justice in Uganda can be grouped under two general categories of:

- i) **Land administration and registration:** which includes land acquisition, registration, titling, and legislation. The multiplicity of land tenure systems in

Uganda including *mailo*, freehold, and leasehold has been a big deterrent to investment. Reforms under the LSSP are geared towards solving these challenges.

- ii) **Land dispute resolution:** which brings to question the laws and capacity of institutions charged with the adjudication and settlement of land disputes that are on the increase in Uganda. These disputes often lead to high costs, deter investments and are a drain on resources of poor households and the economy. Currently, there is a huge case backlog of land disputes in all forums which has been put at over 5,000 cases in the Land Tribunals alone. Land disputes have also resulted in public disorder and mob violence, leading to loss of lives especially in districts like Kibaale.

Under SIP I, JLOS sought to address issues of land justice through the Land Registry by endeavouring to strengthen its capacity for land registration and titling. This component will now be addressed directly under the LSSP (funded by the PSCP II) while JLOS in coordination with other stakeholders will focus on other key challenges including:

- Multiplicity of dispute settlement forums/ methods which leads to “Forum Shopping”, delays in settlement of disputes and creates a backlog. Dispute forums include Local Council Courts, Land Tribunals, Courts, informal dispute resolution mechanisms e.g. clan elders, legal aid service providers, and the police. This also highlights issues of mandate, capacity, coordination, monitoring and supervision of land dispute settlement institutions.
- The rationale and efficacy of the Land Tribunals whose modus operandi of circuiting has contributed to delays in settlement of disputes and increased case backlog
- Low levels of land rights awareness especially among marginalised groups e.g. the Batwa of Western Uganda, refugees e.g. in Nakivale, Internally Displaced Persons in conflict and post conflict affected areas of Northern and South Western Uganda
- Protecting land rights in conflict affected areas of Karamoja and Northern Uganda
- Enforcing gender and land rights- “ownership and consent clauses”, and succession rights especially for orphans and widows.
- Harmonisation of all land laws
- Contribution to the emerging National Land Policy

2.6 Broad Sectoral challenges Preceding SIP II

There are broad sectoral challenges emerging from the foregoing discussion. These challenges if addressed would have a profound impact towards realization of JLOS objectives.

Box 2: Broad sectoral challenges at the forefront of SIP II

- Expediting Legislative Reform
- Addressing the existing case backlog
- Inequitable spread of JLOS Institutions and services
- Enhancing public and user awareness
- Managing a widened scope in a static resource envelope
- Justice Delivery in conflict affected areas

2.6.1 Expediting Legislative Reform

Legislative reform constitutes the core of SIP II reform and the Sector's ability to influence and meet this challenge will determine the pace at which the outlined reforms are attained. The process of law reform can only register impact upon enactment of bills into law. A list of prioritised laws that remain outstanding is attached in **Annex B**.

2.6.2 Addressing the Existing Case Backlog

The case backlog in the Justice System across all focus areas continues to build up at a fast rate not matched by the case disposal rate. By the close of the year 2005 the case load as recorded in the Courts of Judicature Data Centre reads as follows;

Table 1: Case load in Courts of Judicature, 2005

Civil Suits	B/fwd Pending	Registered 2005	Disposed	Pending
Divorce Causes	213	99	99	213
Adoption Causes	3	5	5	3
Civil Appeals	2547	573	329	2791
Civil Revisions	28	21	9	40
Civil Suits	9044	4099	3445	9698
Company causes	1	1	0	2
Administration Causes	1983	1616	1222	2377
Divorce Appeal	1	2	1	2
Election Petitions	16	0	3	13
Family Causes	1342	1043	740	1645
Private Prosecution	6	16	8	14
Originating summons	4	5	3	6
Labour Causes	0	21	15	6
Miscellaneous Cause	100	57	69	88
Miscellaneous Applications	4212	2369	1709	4872
Immigration Cause	0	18	17	1
Miscellaneous Appeals	46	7	2	51
Total civil matters	19546	9952	7676	21822
Criminal matters	32503	42917	38748	36672

Not reflected as pending in the above figures are the land matters that until the amendment of the Land Act in May 2004 fell outside the ambit of the Justice Sector. The transfer of land matters to the Justice Law and Order Sector brings an additional 9,000 registered cases in the year closing 2005. In 2004 alone, Land Tribunals registered 2,458 cases, resolved 300 while 1,033 were part-heard. The Sector therefore seeks to address the existing backlog in affirmation of its commitment to enhance access to fair/speedy justice and adherence to the rule of law.

2.6.3 Inequitable Spread of JLOS Institutions and Services:

Challenges in ensuring rationalised geographical spread of JLOS institutions remain especially in conflict and post conflict areas. In addition, a long-term Human Resource Development strategy is yet to be adopted. Staff numbers do not match the

workload in all JLOS Institutions and this has a negative impact on sector performance as seen below.

Table 2: Court Performance/Work July-October 2005

Name of Court	Cases B/forward	Filed	Disposed	Pending	No. of Judicial Officers	Performance per officer over the Quarter
Supreme Court	N/A ¹⁵					
Court of Appeal	N/A					
High Court	5,679	840	423	6,096	27	15 cases
Chief Magistrate Court	28,851	5,677	5,026	29,502	23	218 cases
Magistrate GI Courts	6,281	2,660	2,600	6,341	90	29 cases
Magistrates GII Courts	4,289	2,652	2,530	4,411	157	16 cases
Total	45,100	11,929	10,579	46,350		

Source: Justice, Law and Order Sector Progress Report June-November 2005

2.6.4 Managing a Widened Scope within a Static Resource Envelope

The expansion of the reform scope from two to four focus areas arouses expectations in the JLOS institutions and the public. This comes at a time when the resource envelope is not expanding yet the Sector has to confront the disparities in needs across all the four focus areas. The challenge calls for enhanced internal and external linkages and rationalisation of roles and resource allocation and utilization.

2.6.5 Service Delivery in Conflict Affected Areas

Decades of war in conflict affected areas of Northern Uganda have severely weakened JLOS structures and constrained their effectiveness in the administration of justice. Key reforms in these areas are currently speared by other sectors and institutions focused on implementing the National IDP Policy. The challenge is on JLOS to develop and implement a strategy to enhance service delivery and access to justice within those reforms. Key challenges include increasing the visibility of civilian administration of justice through establishment of offices and recruitment and posting of adequate staff numbers, development of initiatives aimed at enhancing dispute resolution at the grass root level (e.g. through Alternative Dispute Resolution) and building effective partnerships to enhance legal and civic awareness among internally displaced persons.

2.6.6 Differentials in institutional development and low staff awareness of JLOS

JLOS institutions are at varying levels of development which creates challenges of institutional confidence to implement reforms. Similarly, low levels of staff awareness of JLOS will have an impact in reforms under SIP II unless strategies are developed and implemented to enhance staff awareness, participation and ownership.

¹⁵ Data-Not Available

SECTION IV: THE REFORM PROCESS UNDER SIP II

CHAPTER 3: JLOS SIP II PRINCIPLES AND REFORM PRIORITIES

3.1 JLOS PRINCIPLES

Key Principles Underpinning SIP II

The following principles that underlie SIP II take into account achievements and lessons from SIP I and anticipate the emergence of new challenges and threats over the course of SIP II:

Box: 3: Key Principles underpinning SIP II

- Enhancing impact to the beneficiaries and confidence of users through improved service delivery and accountability
- Enhancing the quality of justice dispensed
- Inculcating respect for human rights (both internally and externally)
- Enhancing awareness and participation of the public, private sector involvement and local level input
- Achieving minimum levels/standards of access to justice for all populations especially those in conflict affected areas
- Integrating parallel structures and fostering intersectoral linkages
- Identifying and promoting low cost solutions
- Integrating cross cutting issues in all programme processes
- Promoting strategies that enhance an Access to Justice versus a Law and Order Orientation through prevention, diversion and rehabilitation
- Fostering access through innovative pilots and approaches
- Strengthening evidence based planning
- Enhancing productivity through improved service delivery
- Poverty reduction and wealth creation through implementation of sound policies and strategies

3.2 JLOS GOAL, PURPOSE AND OBJECTIVES

The JLOS policy framework is drawn from that of SIP I and has been refined as below:

The Mission of the Justice Law and Order Sector is to *ensure all people in Uganda live in a safe and just society.*

The overall Goal of the Sector is the immediate purpose of the PEAP which is:

To enhance quality of life and ensure that poverty in Uganda is eliminated

The justice sector addresses poverty eradication directly through pillar 2, 3 and 4 of the PEAP, 2004 which have been translated into the Sector purpose and key result areas. JLOS together with the Poverty Monitoring and Analysis Unit (PMAU) and Office of the

Prime Minister (OPM) will develop specific indicators at the goal level to monitor progress towards attainment of the PEAP purpose.

The JLOS purpose is:

To improve the safety of the person security of property and access to justice in order to encourage economic development and benefit poor and vulnerable people

The majority of people in Uganda are poor and lack adequate access to justice among other social services. JLOS through its purpose seeks to enhance the public's capacity to seek and demand for improved services and capacity to develop and create wealth through improved awareness of their rights and confidence in the justice system.

To attain this purpose, five sector objectives have been identified as below:

- O.1 To Promote Rule of Law and Due Process
- O.2 To Foster a Human Rights Culture across JLOS Institutions
- O.3 To Enhance Access to Justice for all particularly for the poor and marginalised**
- O.4 To Reduce the Incidence of Crime and promote Safety of the Person and Security of Property**
- O.5 To Enhance JLOS Contribution to Economic Development

3.3 Priority areas for reform over the Medium Term

Under SIP I, JLOS focused its resources on reform of two priority areas of Commercial and Criminal Justice. Following the Medium Term Evaluation of the JLOS SIP I, discussions held at the first National Justice Forum, and findings from studies, JLOS will now extend the focus of the reform programme to include Family and Land Justice which are pertinent to the poor and to economic development in Uganda.

- 3.3.1 Under **criminal justice**, the Sector will enhance its institutional response to crime to address the rising crime rates, engage in crime prevention activities and strengthen pilot initiatives including legislative reform, case backlog reduction programs, human resource development, and increasing the geographical spread of key institutions with specific attention to conflict areas. In addition ongoing efforts to increase the number of personnel to match case load, retool the crime detection and investigation departments and enhance statistical forecasting of crime, increase use of ADR will be accorded priority under SIP II. The Sector will also take positive steps to address prisoner welfare, promote prisoner rehabilitation and community re-integration in addition to pursuing initiatives that ensure Sectoral compliance with the minimum standards for Prisoner Welfare and promote innovative approaches for experience-sharing between civil society and Government institutions.

- 3.3.2 Under **Commercial Justice**, efforts will be made to build on achievements made so far and address the key challenges through mechanisms that will enable improved access to commercial justice countrywide through the formal courts, small claims mechanisms and alternative dispute resolution systems; reform of the regulatory regime to make it more amenable to a conducive business environment; restructuring the business registries, streamlining processes and fostering a customer culture to enhance efficiency and reduce costs of doing business; and building capacity for the legal profession to enable effective delivery of services.
- 3.3.3 Under **Family Justice**, the Sector will at the outset seek a comprehensive appraisal of the key bottlenecks in the administration of family justice. This study will form the basis for a prioritised and sequenced sectoral intervention in family justice. The Sector envisages support towards legislative reform, increasing staff strength, restructuring and retooling family justice institutions including the Administrator General's Office, the Family division in the Judiciary, the Family and Child Protection Units in the Uganda Police Force. Integration of family justice management issues into ongoing Sectoral initiatives including civic and legal education, publicity, performance standards development, de-concentration of services and human resource development will also be pursued.
- 3.3.4 Under **Land Justice**, JLOS will focus on improving land dispute resolution mechanisms while also engaging with other stakeholders to enhance land administration and registration. An **Integrated Study on land dispute systems** will be commissioned prior to commencement of reforms. Activities will aim at streamlining the various dispute resolution mechanisms, strengthening agreed fora especially at the local level, utilising alternative dispute resolution mechanisms, fostering judicial oversight and supervision and utilising innovative approaches e.g. piloting the use of paralegals at Local Council Courts and operationalisation of land courts in a number of prioritised districts/regions identified with a huge backlog and with frequently recurring land disputes e.g. Kibaale district and conflicted affected districts of Northern Uganda.

3.4 Programme Areas and Activities under Key Result Areas

To achieve its purpose and overall goal, JLOS will undertake key activities highlighted under the five key result areas that have been developed. Underpinning all reform processes are key activities that will be implemented to enable realisation of stated objectives.

At the purpose level, three key indicators are identified for measuring progress:

- *% of public that feel assured of safety of the person and security of property increased from an average of 62% to 70% by 2010*
- *70% of public have effective knowledge of their rights and duties vis-a-vis JLOS institutions and how to demand for/ pursue them by 2010*

- *Improved confidence in the justice system from 34% to 55% by 2010*

Key Result Area 1: Rule of Law and Due Process promoted

The rule of law is a keystone to democracy and good governance and calls for the respect of laws and defined processes. The key challenges to the rule of law in Uganda have been the external interference in the judicial process, corruption, slow legislative process, coupled with limited law revision, lack of access to published laws and absence of case precedents. Judicial officers, lawyers and the public should have access to updated statutes and case precedents. Under SIP I, JLOS undertook several processes to amend key laws and will take this process further under SIP II by developing and undertaking strategies to foster the faster enactment and availability of laws and their continuous revision. The sector will develop and implement a strategy to publish and disseminate unified law reports (Uganda Law Reports) including electronic publication of legal materials in a phased approach. This builds upon the Commercial Court initiative of publishing case laws under the Uganda Commercial Law reports (1997-2001).

The National Integrity Surveys of 1998 and 2003 both indicated high public perceptions of corruption in JLOS institutions of Police and Judiciary. Perceptions of corruption of JLOS staff taint the public image of the sector, derail progress and stalls projects aimed at fostering development.

Performance Indicators:

- *Key laws initiated by JLOS that are enacted and enforced by 2010*
- *% of investors, private sector and the public confident of enforceability of contracts, judicial decisions and the law by 2010*
- *% reduction in index of perceived corruption within JLOS institutions by 2010*

Key Actions under KRA 1:

1.1 Certainty of the Law and Procedures Ensured

- 1.1.1 Strengthen identified laws and lobby Cabinet and Parliament for enactment of key laws that seek to enhance access to justice through a multi pronged strategy encompassing JLOS leadership, private sector and civil society (*see list of initial laws identified for review under Annex A*).
- 1.1.2 Enhance access to updated laws and case precedents; Foster partnerships with the private sector; strengthen supervision of existing publishers by fortifying judicial editorial boards;
- 1.1.3 Publication of law reports; also, pilot the compilation and publication of electronic law reports.
- 1.1.4 Continuous law revision; and simplification of laws
- 1.1.5 Strengthen capacity of law drafting institutions.

- 1.1.6 Enhance judicial activism through public interest litigation and implement and monitor adherence to reforms on civil, criminal and evidence procedures.
- 1.1.7 Review and deregulate key processes at institutional level

1.2 Independence of the Judiciary Fostered

- 1.2.1 Train judicial officers, secure legal materials from other jurisdictions;
- 1.2.2 Strengthen law reporting and produce journals so as to build confidence and capacity of the judicial officers to withstand external interference.
- 1.2.3 Maintain a proactive watch to monitor and develop strategies to address threats to the independence of the Judiciary together with other stakeholders including the Uganda Law Society and the media.
- 1.2.4 Support to Uganda law Society through training of lawyers

1.3 Due Process Enhanced

- 1.3.1 Prioritise timely delivery of judgements;
- 1.3.2 Enhance supervision of court brokers/ bailiffs and strengthen enforcement of decisions and judgements in Courts, UHRC tribunals, government departments.
- 1.3.3 Develop and implement key strategies aimed at enforcing constitutional time limits and standards e.g. right to bail, fair and speedy trial and times limits after committal for capital offences; arrest of suspects after sufficient investigation.
- 1.3.4 Enhance capacity of JLOS institutions to enforce the regulations and impose punitive measures for non compliance in businesses;
- 1.3.5 Sensitise government agencies on breach of contractual obligations.

1.4 Accountability and Ethics Enhanced across JLOS Institutions

- 1.4.1 Link closely to activities of the Directorate of Ethics and Integrity (DEI) outlined under the National Anti Corruption Strategy 2004–2007. The focus of reforms is on changing attitudes, work cultures and ethics of the sector staff by promoting consciousness of professional responsibility to work at all staff levels (e.g. through prosecution and sanctioning of corrupt staff).
- 1.4.2 Lobby for pay reform; and ensure minimum packages e.g. basic equipment to enable officers operate
- 1.4.3 Training, and awareness raising
- 1.4.4 Strengthen institutional disciplinary mechanisms including those for paralegals and lawyers;
- 1.4.5 Develop procedures manuals at institutional level;
- 1.4.6 Develop performance standards with set targets;
- 1.4.7 Develop and disseminate client charters or user guides to enhance staff accountability, promote zero tolerance to corruption and enhance public awareness.

Key Result Area 2: Human Rights Culture fostered across JLOS institutions

Justice systems are hinged on human rights principles which are enshrined in international and regional treaties, national Constitutions and laws. The role of JLOS institutions is to protect and promote these human rights, including the right to a fair and speedy trial, and the non- derogable right on freedom from torture. Pillar 4 of the PEAP highlights key human rights challenges for the sector to address including low levels of human rights awareness, and human rights violations in institutions.

Over the course of SIP II, the sector will develop strategies and activities to incorporate and uphold international human rights standards which have been domesticated into the Constitution, local law and polices into all its goals, programmes, policies and budgets at all levels. These measures are aimed at fostering a human rights culture, reducing the incidence of specific human rights violations and restoring public confidence in JLOS institutions.

Performance Indicators:

- *Reduction in incidence of specific human rights violations categorised by type and institution by 2010*
- *Systematic consultative and feedback mechanisms developed for UHRC, CSOs and private sector to input into policy formulation processes at local, regional and national level by end 2007*

Key Activities under KRA 2:

2.1 Human Rights Awareness and Practice Enhanced at Institutional and Sectoral Levels

- 2.1.1 Develop and implement strategies to enhance staff awareness and application of key human rights laws and principles and systematically integrate human rights principles in all induction and training programmes for staff, and operational procedures.
- 2.1.2 Develop a change management strategy and human development plan to inculcate a positive approach of social responsibility among staff, improve customer service and minimise the strong law and order orientation; and monitor the compliance to human rights principles in practice and enforcement of codes of conduct.
- 2.1.3 Promote the rights based approach to service delivery within all JLOS institutions.

2.2 Incidence of specific human rights violations reduced.

- 2.2.1 Conduct a baseline to establish types/occurrence of specific human rights violations in institutions; initiate a Law against Torture (*as part of KRA 1*);
- 2.2.2 Implement measures to realise minimum conditions in facilities of detention;

2.2.3 Pilot model police stations to promote victims and accused persons rights; institutionalise complaints mechanisms and develop systems of strengthening institutional and individual accountability.

2.2.4 Establish a framework of cooperation with UHRC and other security agencies to minimise occurrence of human rights violations and to promote public confidence in the sector.

2.3 Conducive Environment for Human Rights CSOs and the Private Sector to Effectively Participate in JLOS Fostered

2.3.1 Develop and implement mechanisms for engaging with CSOs and the private sector in a structured manner at national, regional and local levels. Partnership principles will be adopted to regulate the relationship.

2.3.2 Engage CSOs and the Private Sector through Working Groups, Users Committees, Bi annual reviews and JLOS Forums. The format utilised at the Commercial Court Users Committee will be adopted to ensure participation.

Key Result Area 3: Enhanced Access to Justice for all Especially the Poor and Marginalized Groups

Not all people in Uganda have equal access (includes availability and accessibility) to the justice system. The poor and marginalised groups¹⁶ still bear unreasonable burdens taking the form of physical distance to JLOS institutions, cost of access, language and attitudinal barriers and existence of conflict situations. The Sector also recognizes that the people’s needs and aspirations of the justice system are closely intertwined with their livelihood opportunities. Obtaining a speedy and fair remedy in a land dispute, a safe and value-free forum to be heard in a domestic violence case, being informed and consulted as a victim in a criminal case, and settlement of contractual disputes all happen in people’s daily lives and JLOS failure to adequately respond negates the economic and social development efforts undertaken in other sectors. The Sector shall engage civil society, private sector and local governments to foster meaningful and substantive access to justice for all people in Uganda.

Performance Indicators:

- *% of public with access to JLOS institutions increased from 25% to 50% by 2010*
- *Average time spent on remand after committal reduced to under 2 years for capital offences and 6 months for petty offences (after hearing starts), and 3 months for juveniles by 2010¹⁷*
- *Fast track and small claims systems developed and instituted in all courts/procedures by end 2010*
- *50% increase in disposal rate for cases and services within set benchmarks for each institution by 2010*

¹⁶ The PEAP 2004 categorises the marginalized to include juveniles, women, people in conflict affected or remote areas, HIV/AIDS patients, and the poor

¹⁷ Time limits may be revised with the adoption of the amendments to the Constitution 1995 which prescribe lowering limits from 120 to 60 days in the lower courts and 360 to 180 days in the high court

- Increased % of vulnerable groups in need of legal aid who have access to satisfactory and timely legal aid services by 2010
- 30 % increase in use of alternative processes for fair resolution of disputes by 2010
- 60% of local council courts meeting set benchmarks for quality and effectiveness by 2010

Key Activities under KRA 3:

3.1 Rationalised physical access and availability of JLOS institutions and functions ensured

- 3.1.1 Develop and implement a rationalised, coordinated and cost-effective strategy to enhance physical access of JLOS institution countrywide (to be governed by established criteria which will be developed and may include remoteness, conflict, demographic factors, and establishment gaps). Focus will be on conflicted affected areas of Northern Uganda and remote, difficult to reach and insecure areas e.g. Bundibugyo, Kalangala, Karamoja.
- 3.1.2 Prioritised construction, renovation and equipment of offices. The sector will also recruit, induct and train staff and judicial officers in a phased manner.
- 3.1.3 Develop and implement costed and prioritised plans for the merger of central and local Government Police and Prisons.

3.2 Financial bottlenecks hampering access to justice minimised

- 3.2.1 Develop a policy, costed plan and national framework for the provision of legal aid countrywide
- 3.2.2 Promote use of alternative dispute resolution mechanisms so as to reduce the financial costs of access (*see 3.3.1 below*)
- 3.2.3 Evaluate and improve the State Brief scheme
- 3.2.4 Monitor standards of legal aid service provision and the pro bono scheme.
- 3.2.5 Deregulate judicial and other procedures (e.g. registration of services) to reduce costs and delay; and review and reform bail practices.
- 3.2.6 Develop, implement and integrate innovative pilots and low cost models of legal aid (in coordination with the Legal Aid Basket Fund) including the Para-legal Advisory Services (PAS); Juvenile justice fit persons programme, use of paralegals. Research findings and best practices will be documented for replication countrywide.

3.3 Use of alternative dispute resolution mechanisms (ADR) and innovative approaches to enhance justice

- 3.3.1 Evaluate the Mediation Pilot Project and extend the use of ADR mechanisms to all focus areas (land, commercial, family and criminal justice) with emphasis on conflict affected areas of Northern Uganda.
- 3.3.2 Develop and implement a regulatory framework and standards for ADR.
- 3.3.3 Train Sector staff and enhance awareness of the public and users (e.g. advocates, Executive Committee Courts officials) on benefits of ADR (in partnership with

- civil society and the private sector). Strengthen record keeping and judicial oversight over ADR mechanisms.
- 3.3.4 Support to the National Community Service Programme
 - 3.3.5 Identify and promote other innovative approaches aimed at enhancing access to justice including use of mini sessions, *nolles prosequi*, reviewing the session system.

3.4 Capacity and Role of Local Council Courts (LCCs) in easing access to justice strengthened

- 3.4.1 Strengthen linkages with the Ministry of Local Government and streamline funding of LCCs with MoLG Strategic Investment Plan, JLOS SIP II and United Nations Capital Development Fund (UNCDF) and UNDP.
- 3.4.2 Coordinate with MoLG to strengthen lower level local courts (Local Council Courts) through training; dissemination of guidelines and key laws; strengthening record keeping and awareness of human rights and laws taking into account lessons from the Joint Legal Aid and Local Council Courts Survey.
- 3.4.3 Strengthen supervision mechanisms over the LCCs through support to the sectoral monitoring mechanisms and the Judiciary which has oversight over the judicial operations of the LCCs. Link with MoLG annual inspections of LCCs.
- 3.4.4 Enforce and implement the Local Council Courts Amendment Act 2006, which seeks to enhance the jurisdiction of the lower courts and separate judicial and administrative functions at the sub county level.

3.5 Quality of Justice Delivered enhanced

- 3.5.1 Develop and enforce minimum standards of service delivery and improve quality of outputs of judicial decisions and other processes e.g. sanctioning, mentioning, withdrawals, adjournments.
- 3.5.2 Develop and monitor time standards and targets at institutional level linked to sectoral indicators e.g. level of withdrawals vs. full completion of cases, acquittals vs. dismissals
- 3.5.3 Develop and implement gender and access to justice strategy
- 3.5.4 Develop and implement comprehensive Human Resource Development Strategy and Programmes
- 3.5.5 Strengthen records management across the sector through reviewing and strengthening Management Information Systems, Case management Systems and data bases
- 3.5.6 Conduct a systematic review and reform of operational systems.
- 3.5.7 Evaluate, review, and integrate existing pilots aimed at reducing backlogs, improving administration and creating efficiency savings in the Sector including the Prisons Farm Project, the Police Vehicle Fleet Management Systems, Case Backlog and Chain Linked.

3.6 Technicalities that hamper access to justice minimised

- 3.6.1 Develop and implement a comprehensive information dissemination strategy to increase information available to the public, expand dialogue between the communities and JLOS agencies, enhance dissemination of JLOS information and increase public knowledge about complaint procedures.
- 3.6.2 Develop a human rights based model and contribute to the National Civic Education Programme which is aimed at enhancing public awareness of rights and obligations.
- 3.6.3 Develop and disseminate Information, Education and Communication (IEC) materials on JLOS (user guides) and simplified laws, translated in at least four regional languages.
- 3.6.4 Phased recruitment, training and deployment of interpreters/ translation services at key points in the JLOS.
- 3.6.5 Evaluate ongoing pilots on community policing with a view to strengthening and replicating them especially in conflict affected areas of Northern Uganda.
- 3.6.6 Pilot model police stations and paralegal services in identified areas
- 3.6.7 Enhance public awareness and participation by developing and implementing a multi pronged JLOS publicity strategy that involves key aspects such as regular national press briefings by JLOS leadership, Cabinet memos, and holding annual court open days in each chief magisterial area.

Key Result Area 4: Incidence of crime reduced and safety of persons and security of property promoted

Globally, crime ranks with corruption and uncertainty of policy and judicial behaviour as serious problems that increase the cost of doing business in a country and aggravates levels of poverty. In the wake of lawlessness and inadequate protection from theft, violence and other acts of predation, markets cannot develop and property rights are least effective. In Uganda, crime annually results in loss of billions of shillings, loss of lives, and destruction of property and is a deterrent to investment. The sector has a key challenge of managing the current crime situation in the country with an increasing population, increasing crime rate and high re-offending rate at 43%. In the last 5 years, crime reported is up at 45%, the incidence of crime is still high at 30 crimes per 10,000 people. Crime statistics in the Criminal Baseline survey report over 50,000 crimes and in 2005, crime is estimated to have cost the economy over Shs. 39 billion.

CID reports that the offences of simple and aggravated robbery, burglary, defilement, domestic violence, theft and house breaking are on the increase. Cross border crimes including white collar crimes, drug trafficking, terrorism are also on the increase, generate a climate of fear and deter investments. Reducing the incidence of crime is critical for economic development and poverty eradication. To complement national efforts to enhance the credibility and competitiveness of the nation as a hub of investment and economic growth the sector has prioritised one of its key result areas on reducing incidence of crime and promoting security of persons and safety of persons.

Performance Indicators:

- *Incidence of crime reduced from 30 crimes per 10,000 people to 20 crimes per 10,000 by 2010*
- *% reduction in index of perceived crime prevalence by 2010*
- *Rate of recidivism reduced from 43% to 30% by 2010*
- *Perceptions of safety and security of person and property/ investments increased at local and international levels by 2010*

Key Activities under KRA 4:

4.1 JLOS response to crime enhanced

- 4.1.1 Strengthen capacity of crime fighting agencies through restructuring, training
- 4.1.2 Strengthen established specialised crime investigations, detection , surveillance and fraud units by equipping them with essential communication and operational equipment and re-organisation, recruitment and capacity building
- 4.1.3 Phased recruitment of police and prisons officers and other categories of JLOS staff to attain agreed ratio and reduce caseload e.g. Police 1:500 persons; prisons 1 warder: 3 prisoners. Current CID caseload is 1 officer: 27 cases against the desired ratio of 1:12.

4.2 Recidivism rates reduced

- 4.2.1 Prioritise and improve the collection of adult offender and juvenile data and improve information systems for tracking offenders
- 4.2.2 Develop and implement cross institutional/sectoral programmes to improve criminal history records and offender identification.
- 4.2.3 Evaluate rehabilitation programmes and develop and implement a strategy aimed at promoting rehabilitation of offenders (including juveniles) to reduce the levels of recidivism in the country.
- 4.2.4 Improve medical, vocational and educational programs in prisons (in coordination with other stakeholders including Ministry of Education and UNAFRI) to maintain sound health, and prepare offenders to gainfully support themselves and their families upon release.
- 4.2.5 Widen avenues of communication to maintain and strengthen family and community ties of incarcerated offenders and embark on a public relations strategy to enhance public awareness.

4.3 Crime prevention strategies developed and implemented

- 4.3.1 Review and strengthen the crime prevention policy and develop and implement strategies aimed at halting the increasing growth in the crime rate by e.g. developing national campaigns against specific crimes such as child related crimes.
- 4.3.2 Strengthen the community policing and neighbourhood watch programmes so as to enhance community awareness, and encourage the public to report crimes and participate in crime prevention programmes.

- 4.3.3 Partner with regional and international organisations to combat global crimes and work with national security organisations
- 4.3.4 Foster partnerships with CSOs, the Private Sector and Local Governments to promote safety and security e.g. on fire fighting
- 4.3.5 Legislative reform to minimise the use of legislative sanctions as a mode of social control and to address more sophisticated crime e.g. e-crime (*see KRA 1.1*)
- 4.3.6 Pilot model police stations that enhance customer care and service, improve information available to the community and lay emphasis on categories of the population with disproportionate crime rates;
- 4.3.7 Strengthen the intelligence gathering efforts in the Uganda Police Force (*see 4.1 above*) and Immigration Department to assess and utilize data and establish patterns relevant for decision making.
- 4.3.8 Identify and target particular crimes that have a multiplier effect on the other Sector objectives. The reduction of family based violence, child related crime, land disputes, white collar crime and fraud are directly related to the promotion of safety of the person and security of property.

4.4 **Safety of the person and security of property promoted**

- 4.4.1 Define and prioritise threats to safety and security within the mandate of the Sector, and design and implement collaborative partnerships with the private sector, local government and civil society in the context of limited nationwide statistics on safety of the person and security of property.
- 4.4.2 Develop and implement costed and prioritised strategy based on input at the district levels as coordinated under the Office of the Prime Minister. Contribute to overall GoU programmes under the PEAP Pillar 3 which are aimed at enhancing security, conflict resolution and disaster management especially in conflict affected areas of Northern Uganda, and Karamoja.
- 4.4.3 Enhance civilian administration of justice through phased increased presence of JLOS institutions (e.g. posting police officers in the IDP camps), community policing initiatives, legal awareness programmes and support to operationalising services e.g. through sustained mobile courts in Karamoja region

Key Result Area 5: JLOS Contribution to Economic Development Enhanced

Under SIP II, JLOS reforms will be geared to making the justice system responsive to Uganda's growth demands as articulated under Pillar 2 of the PEAP on enhancing productivity and competitiveness. Among Uganda's competitive disadvantages on the global scale are; organised crime, slow processes (e.g. in settlement of disputes), unfavourable property rights and laws (e.g. laws on land ownership, employment laws) and favouritism in decisions of government officials. Processes in government institutions (e.g. on registering a business) are also slowed by layers of bureaucracy and red tape.

Promotion of economic development largely falls in the mandate of other government of Uganda ministries and departments including the Ministry of Tourism Trade and Industry. The JLOS reforms however, impact on economic development in the country by providing a conducive environment for investment, growth and wealth creation. JLOS institutions will strive to contribute to a conducive business environment that enables businesses to compete on the domestic, regional and global scene by ensuring efficient and timely delivery of services/information, quicker settlement of disputes, reviewing and shortening processing to reduce time and costs of doing business and harmonisation of international and regional agreements with domestic policy, laws and regulations. JLOS will also aim at improving service delivery by strengthening capacity of sector institutions and fostering public/public and public/private partnerships.

The linkage between the impact of reforms in commercial justice and how they are affected by the status of the family, criminal and land sector reforms is critical to the achievement of this KRA. For example an inefficient estate management and succession mechanism and a poorly managed land conveyancing mechanism has a direct bearing on economic development because it affects property rights/ownership and discourages investment.

JLOS will make a deliberate effort to create linkages between its key target sectors, to take advantage of synergies that can reinforce the sector's contribution to economic development. These include the Medium Term Competitiveness Strategy (MTCS), Ministry of Trade and Industry (MTTI), regulatory institutions (UIA, UCDA, and Electricity Regulatory Authority) (see table on intersectoral linkages in chapter 4); regional organisations (e.g. EAC); and the private sector

Performance Indicators:

- *Improved perception by local and foreign investors of Uganda's legal environment*
- *Improved lenders' and borrowers' confidence in legal environment and in instruments for accessing credit e.g. land titles, mortgages)*
- *Reduction in time and cost taken to conduct legal business e.g. register a company, enforce a contract in court,*
- *Increased confidence (private and public sector) in ability to enforce contracts and business decisions*
- *Enactment of laws and procedures that enhance economic development*
- *Increased gender parity in JLOS delivery of services that promote economic development*

Key Activities under KRA 5:

5.1 Conducive strategies developed and implemented to support production, competitiveness and wealth creation

- 5.1.1 Develop and implement strategies for fostering institutional commitment and enhancing service delivery e.g. on criteria for minimum service delivery, customer care, and creation of a business environment in JLOS institutions.
- 5.1.2 Strengthen institutional and organizational capacity to fulfill institutional mandates.
- 5.1.3 Develop and implement specialised training programmes to enhance skills and awareness of JLOS staff
- 5.1.4 Conduct an integrated study on Land and Family justice
- 5.1.5 Participate in streamlining of the Land Sector Policy and a review of the land laws.
- 5.1.6 Review and revise key processes to minimise costs of doing business e.g. business searches and registration, trial, appeals, land registration, administration of estates;
- 5.1.7 Pilot small claims and fast tracking mechanisms aimed at resolving disputes faster.
- 5.1.8 Establish Users Committees to provide consultative and feedback mechanisms for improvement of service delivery.
- 5.1.9 Establish institutional, sectoral and intersectoral linkages with other public and private institutions and organisations which are key players in economic development.

5.2 Non Tax Revenue (NTR) increased

- 5.2.1 Implement financial management strategy
- 5.2.2 Review systems for collection of non tax revenue
- 5.2.3 Develop strategies to generate more non tax revenue
- 5.2.4 Lobby for revision of fines and other matters
- 5.2.5 Lobby Government to recognise JLOS contribution to the consolidated fund through NTR and retention of costs at source

5.3 J/LOS contribution to creating an environment that enables Uganda to comply with and take advantage of the regional, bilateral and international trade agreements strengthened

- 5.3.1 Develop and implement specialized training programmes, enhance skills and create awareness amongst JLOS staff about the direct linkage between public sector performance and economic development.
- 5.3.2 Review operations of Industrial Court
- 5.3.3 Link and benchmark JLOS performance indicators with competitiveness indicators

- 5.3.4 Up date and harmonise key domestic, regional and international laws and procedures that affect the business environment, stifle investment and hence dampen economic growth.
- 5.3.5 Align law reform priorities across the Key Result Areas to focus on competitiveness imperatives by working with businesses and the legislature to identify which are the critical laws and regulations that need to be fast tracked so that the economy can thrive.

3.5 Programme Management

The Sector Secretariat will undertake several key processes and programme management activities aimed at supporting implementation of the identified activities under the five Key Result Areas. These activities are discussed in more detail under Chapter 5 and include: initiating studies and consultancies; preparing regular reports; organising annual reviews and the National JLOS Forum.

CHAPTER 4: STRATEGY TO IMPLEMENT SIP II

4.1 Strategies to Achieve the JLOS Objectives

There are five key aspects to the strategy for implementing SIP II to wit:

- a) Strengthening advocacy to promote and enlist political support for JLOS reforms
- b) Integration of cross-cutting issues
- c) Enhancing inter-sectoral linkages
- d) Ensuring effective participation of the Private Sector and CSOs
- e) Enhancing community involvement in JLOS operations
- f) Enhancing service delivery in conflict affected areas

4.1.1 Strengthening Advocacy to Promote JLOS Reforms

As chapter 3 indicates, a dynamic agenda for law reform lies at the core of the entire JLOS reform process. This agenda can only be achieved through firm and consistent follow up at Cabinet and Parliament. In SIP II therefore JLOS will invest in advocacy to enlist support for the reforms through the Leadership Committee. Initiatives will include but not be limited to; presentation of Cabinet Memos by the Minister of Justice and Constitutional Affairs to his counterparts on the JLOS strategy, and meetings between representatives of the Leadership Committee and the Speaker of Parliament.

4.1.2 Integration of Cross-cutting Issues

The JLOS purpose is one from which all people should benefit regardless of nationality, gender, socio-economic status, age, location and other factors that form a basis for discrimination, marginalization and disempowerment. In aspiring towards a national justice strategy that is relevant and inclusive, the JLOS SIP II addresses itself to '*cross-cutting issues*' of relevance.

The approach to addressing '*cross-cutting issues*' within SIP II is anchored on two pillars of mainstreaming and utilizing inter-sectoral linkages and collaboration. The mainstreaming approach integrates the relevant issues directly within the definition of sub results, activities and performance indicators, as well as the management structures and processes. This will also involve reliance on the financial resources available for SIP II implementation wherever such need arises.

The JLOS Secretariat will task a member of its staff to oversee integration of all cross-cutting issues within the implementation of SIP II.

4.1.3 Cross-cutting Issues of Relevance

Cross-cutting issues of relevance to be addressed within SIP II include poverty, conflict and internal displacement of people, HIV/AIDS, gender-based discrimination and

inequality, environment, juveniles, disability, governance, and rights of ethnic minorities. Below is a mapping of planned responses to the cross-cutting issues¹⁸:

i) Poverty

In response to the implications of poverty for access to justice JLOS responses within the SIP II include:

- ☞ development and implementation of a pro-poor national legal aid policy
- ☞ establishing linkages with a pro-poor legal aid basket fund (LABF)
- ☞ promoting pro-poor alternative dispute resolution mechanisms
- ☞ diversion of juvenile offenders from the formal justice system
- ☞ decriminalization of petty offences
- ☞ Strengthening Local council courts which are more accessible to the majority of the population
- ☞ Legal rights awareness activities by both JLOS agencies and other actors.

ii) Conflict and Internal Displacement of Persons

JLOS responses to areas affected by conflict and internal displacement within the SIP II are based on the recognition that not everything can be done at once and will therefore promote simpler initiatives for more effective results in the short-term. The responses also recognize the need for JLOS to work through ongoing initiatives such as the National Resettlement and Re-integration Strategy spearhead by the Office of the Prime Minister (OPM). Interventions within SIP II include:

- ☞ recognition of conflict affected areas among the criteria for rationalized JLOS de-congestion
- ☞ Piloting support to traditional justice systems with an emphasis on respect for human rights.
- ☞ Implementation of crime prevention programmes in conflict affected areas, hand in hand with a gradual improvement in formal policing.
- ☞ Support to existing administrative arrangements for law and order within IDP camps with a focus on protection and rights of women and children.
- ☞ Ensuring JLOS active participation in implementation of the IDP Policy at all levels – national, sectoral and district.
- ☞ Ensuring JLOS participation in the implementation of a National Resettlement and re-integration Strategy spearhead by OPM
- ☞ Improved access to primary legal aid and use of paralegals
- ☞ Support to Land Tribunals within conflict affected areas
- ☞ JLOS participation in transitional justice initiatives
- ☞ Participating in disarmament programmes in Karamoja area
- ☞ Establishing systematic collaboration with the OPM, the Amnesty Commission and the DTG NARC.

¹⁸ The implications for JLOS arising from poverty, conflict and internal displacement as well as HIV/AIDS are elaborated upon in Chapter 1 on the socio-economic context. Implications relating to Gender-based discrimination, Environment, Juveniles, Disability, Governance, and Ethnic minorities are elaborated in Table 3.

- ☞ Linkages with innovative approaches on justice in conflict supported under Legal Aid Basket Fund (LABF).

iii) HIV/AIDS

While recognizing the enormity of problems arising from the HIV/AIDS pandemic, responses under SIP II will focus on ensuring maximum benefits within the available resources nationally and globally. The interventions will also involve consolidation of already ongoing initiatives within various JLOS institutions. Responses within SIP II include:

- ☞ review and strengthening implementation of HIV/AIDS Strategies within institutions such as the Police and Prison Service.
- ☞ in collaboration with the Uganda Aids Commission, develop and implement institutional HIV/AIDS strategies for all JLOS institutions.
- ☞ ensuring JLOS active participation in the implementation of the National Policy on HIV/AIDS and the World of Work 2003.
- ☞ review and amendment of legislation on sexual offences and the administration of estates to respond to emerging challenges.
- ☞ In collaboration with other actors, strengthen awareness and sensitivity of JLOS personnel to HIV/AIDS issues in their areas of work. Examples here include Uganda Coalition on HIV/AIDS at the work place, Action Aid International-Uganda, Uganda Network on Law and Ethics (UGANET).

iv) Gender-based discrimination, Environment, Juveniles, Disability, Governance, and Ethnic minorities.

Table 3 below provides an overview of the cross-cutting issues above as well as approaches to their integration within SIP II.

Table 3: Overview of key cross-cutting issues to be mainstreamed in SIP II

Cross-cutting issues	Key issues and implications for JLOS	Integration within SIP II
Gender-based discrimination and inequality	<ul style="list-style-type: none"> - Attitudes of law enforcement personnel - Due to gender inequality women constitute majority of the poor and are ignorant of their rights - The cost of accessing justice is higher for women - women’s rights to own land are limited by patriarchy - women more affected than men by long distances to JLOS institutions 	<ul style="list-style-type: none"> - Establish a Task Force to Develop a JLOS Gender Strategy - Enlist short-term technical assistance to oversee the development and implementation of the JLOS Gender Strategy - include promotion of gender equality among the criteria for selecting priority activities - gender responsive design of activities - Linkages and feedback with innovative approaches on gender and access to Justice (under LABF)
Environment	<ul style="list-style-type: none"> - a large number of poor communities (such as slum dwellers) are likely to come into conflict with the law for non-compliance with environmental 	<ul style="list-style-type: none"> - JLOS legal awareness programmes to incorporate environment issues - Linkages developed with National Environmental Authority to ensure

Cross-cutting issues	Key issues and implications for JLOS	Integration within SIP II
	<p>regulations while pursuing their livelihoods (wetlands, gazetted forests and reserves, poachers)</p> <ul style="list-style-type: none"> - occupational health and safety of workers 	<p>systematic and sustained capacity building for JLOS officials on handling environment issues</p> <ul style="list-style-type: none"> - Enforcement of legal provisions and regulations on environmental protection including occupational health and safety of workers. - Ensuring Land Use Policy does not violate rights.
Juveniles	<ul style="list-style-type: none"> - Poor families increase the incidence of juvenile delinquency. - Juvenile delinquency is on the rise due to high poverty levels - Few and mostly in operational remand homes resulting in juveniles being incarcerated with adults 	<ul style="list-style-type: none"> - Decriminalization of petty offences - Promoting diversion as a key principle of JLOS - Linkages with CSOs engaged - Review role and structures of probation services
Disability	<ul style="list-style-type: none"> - Physically and mentally impaired persons face obstacles such as accessing information and inadequacy of JLOS institutions - mentally impaired persons susceptible to abuse of rights and use by others to commit crime - due process guarantees in determining mental and physical impairment are weak 	<ul style="list-style-type: none"> - guidelines to ensure JLOS constructs user friendly infrastructure - JLOS agencies undertake to ensure the blind, deaf and dumb have access and can obtain services. - Strengthen due process guarantees in determining mental and physical impairment
Governance	<ul style="list-style-type: none"> - Ethics and integrity in service delivery - Accountability by the sector and individual institutions - Transparency and openness of JLOS processes - Participation and inclusion - Non- discrimination 	<ul style="list-style-type: none"> - enhancing community participation elaborated as a major aspect of the strategy. - Ensure enactment of laws to enhance governance including Whistle Blower's Act, Witness Protection, and Access to Information. - Work towards specified targets with the accountability sector - developing and enforcing codes of conduct and complaints systems in JLOS institutions
Ethnic minorities	<ul style="list-style-type: none"> - Discrimination and social exclusion - Limited awareness of rights - Non protection of rights e.g. land rights for the Batwa people, Karimojong - 	<ul style="list-style-type: none"> - Encompassing discrimination and social exclusion under legal awareness programmes - Studying and documenting key challenges in access to justice within these communities to inform strategies - Linking in to work being done by UHRC

4.2 Utilizing Inter-sectoral linkages and collaboration

This will take different forms depending on how common objectives can best be pursued through JLOS mechanisms or those of identified partners. There will be a more limited reliance on SIP II implementation resources here than within the mainstreaming approach.

In order to implement its SIP, JLOS will liaise with other stakeholders - institutions, sectors, and initiatives - through existing fora, and through structured mechanisms such as the UHRC and the Accountability sector. Of the many relevant fora and complementary sectors, JLOS has prioritised which relationships to foster and how (see table 4 below). These relationships are not intended to be solely for sharing information, but should also create accountability, creative solution-generation and grass-roots co-operation in cross-cutting areas. Some are mirrors of higher-level linkages, (e.g. Cabinet-level) wherein the cooperation needs to be carried down to local level in order to see actual benefits accrue to the public.

Table 4: Inter-sectoral Linkages and Collaboration

Broad sectoral area	Institution (s)	Key Issues of Discussion & Nature of relationship
Economic Development	Medium Term Competitiveness Strategy (MTCS) Secretariat	<ul style="list-style-type: none"> ▪ Key issues of discussion include monitoring JLOS contribution to economic development ▪ URSB & Lands Registry part-funded by PSCP II through MTCS ▪ MTCS a member of Commercial Court Users Committee (CCUC). <p>➤ The Coordinator MTCS to sit on JLOS Commercial Justice WG</p>
	Uganda Investment Authority (UIA)	<ul style="list-style-type: none"> ▪ Monitoring investor confidence and satisfaction in JLOS services and reforms ▪ Currently on CCUC <p>➤ UIA representative to sit on JLOS Commercial Justice WG.</p>
	Presidential Investors' Round Table (PIRT)	<ul style="list-style-type: none"> ▪ Top-level Presidential reform initiative to drive and monitor economic development ▪ MoJCA and ULRC Chairman sit on Regulatory Environment WG of PIRT <p>➤ MoJCA and ULRC should represent sector in this regard and inform secretariat/ committees of developments</p> <p>➤ Chair of Regulatory Env. WG to sit on JLOS Commercial Justice WG.</p>
	Regulatory Best Practice Unit (MoFPED)	<ul style="list-style-type: none"> ▪ JLOS integrating Regulatory Best Practice into both law-making and organisational processes ▪ Working linkages established with ULRC and FPC (MoJCA) <p>➤ Representative to sit on JLOS Commercial Justice WG</p>

Broad sectoral area	Institution (s)	Key Issues of Discussion & Nature of relationship
<p>Conflict/ post-conflict affected areas</p>	<p>Office of the Prime Minister /Dept of Disaster Preparedness & Refugees (OPM/DDPR)- Implementation of the National IDP Policy</p>	<ul style="list-style-type: none"> ▪ Prioritising and mainstreaming conflict. Protection of vulnerable persons in conflict/post-conflict areas ▪ District Rehabilitation and Reintegration Plans have been developed and amalgamated by OPM. JLOS to integrate justice issues into these plans ▪ IDP Policy to be monitored by OPM ▪ JLOS institutions including MoJCA, MIA, MGLSD sit on various coordinating committees at Ministerial (IMPC), Technical (IATC) and District (HRPP Sub-Committee and District Security Committee) level ➤ JLOS to seek sectoral representation on these committees ➤ Institutional leaders to provide feedback to JLOS LC & SC ➤ District-level linkage with JLOS Coordination Committees ➤ M&E coordinators at OPM to sit on Safety and Security WG
	<p>Ministry of Defence (MOD)/ Internal Security Organisation (ISO) / Chieftaincy of Military Intelligence (CMI)</p>	<ul style="list-style-type: none"> ➤ JLOS to attend MOD annual reviews ➤ Security agencies to attend working groups on security and human rights ➤ Returning civilian administration of justice in conflict affected areas (phased replacement of armed forces) ➤ Fostering a Human rights culture across JLOS ➤ Interventions in justice processes e.g. arrest, investigation ➤ Intervention by UHRC for joint meetings ➤ Ongoing annual interaction with CMI, Police and DPP an entry point for structured discussions with security agencies
	<p>Amnesty Commission</p>	<ul style="list-style-type: none"> ➤ Minister of Internal Affairs on LC - provide feedback to JLOS Secretariat ➤ Reintegration of ex- combatants ➤ Legal & civic awareness-raising in conflict affected areas
<p>Accountability sector</p>	<p>Inter-Agency Forum</p>	<ul style="list-style-type: none"> ➤ Accountability issues in JLOS- implementation of the National Anti Corruption Strategy 2004-2007 ➤ Sectoral level representation by the JLOS Secretariat in addition to the institutional representation by Police, DPP, Judiciary. ➤ Annual structured meeting: JLOS & Accountability Sector ➤ JLOS representative to attend Accountability Sector Reviews and vice versa
	<p>Uganda Human Rights Commission (UHRC)</p>	<ul style="list-style-type: none"> ➤ UHRC to attend JLOS reviews and vice versa ➤ Representatives of UHRC on sectoral Working Groups ➤ Structured meeting between JLOS and UHRC in the course of design and monitoring leading to the UHRC annual report. ➤ Training on Human Rights Based Approach

Broad sectoral area	Institution (s)	Key Issues of Discussion & Nature of relationship
Other Sectors and Line Ministries/ institutions	Min. of Gender, Labour & Social Development (MoGLSD)	<ul style="list-style-type: none"> ▪ Gender and Juvenile justice issues ▪ Operation of District probation and welfare offices ➤ Attendance of Permanent Sec. at JLOS SC & representation on TC and Working Groups (invite Minister to Leadership on specific occasions)
	National Juvenile Justice Committee	<ul style="list-style-type: none"> ▪ JLOS is represented by DPP & Police. Participation of CSOs. Feedback by Police and DPP to both Family Justice & Criminal Justice WGs and direct to JLOS Secretariat
	Min. of Tourism, Trade & Industry	<ul style="list-style-type: none"> • Existing champion of Regulatory Best Practice in context of reducing the cost of doing business ➤ Under-Sec. to sit on JLOS Technical Committee
	Min. of Water, Lands & Environment (MoWLE)	<ul style="list-style-type: none"> ▪ Input to National Land Use Policy ▪ Land Act reforms ▪ Reform of Land Registry ▪ Liaise over Land Tribunal system, now being reformed under Judiciary (Land Division) ▪ NEMA Environmental Law reform process ➤ JLOS to seek representation on LSSP working committees- ➤ MoWLE (Land Registry) representative to Land Justice WG
	Min. of Local Gov't/ Decentralization (MoLG)	<ul style="list-style-type: none"> ▪ Comm. for LC Courts on Tech. Committee. ▪ LC Courts system to be strengthened, ➤ Define single district-level JLOS Coordination Committee
	Min. of Health	<ul style="list-style-type: none"> • Health issues for Staff and prisoners (esp. HIV/ AIDS) ➤ JLOS to attend annual reviews and JLOS Secretariat to link with Dept. of Planning & Development
	Min. of Education & Sports (MoES)	<ul style="list-style-type: none"> ▪ Formal education for prisoners and staff dependants ➤ JLOS to attend annual reviews and JLOS Secretariat to link with MoES Planning unit

4.3 Effective Participation of CSOs and the Private Sector

Both CSOs and the Private sector have a monitoring, advocacy and feedback function within JLOS. Both categories also play a complementary role to JLOS in service delivery. Creating a conducive environment for civil society and private sector participation to execute these dual roles is therefore imperative. As a basis for their involvement, JLOS, CSOs and the Private Sector will collaborate in the development of **Partnership Principles** to guide their participation in SIP II.

4.3.1 CSOs:

Strong CSO involvement is to be sought and encouraged at Working Group level, as well as in district level JLOS Coordination Committees. Relevant CSOs will be invited as standing members of these committees and will be encouraged to present structured reports to facilitate discussions on key priorities of the sector. Over and above the structured arrangements, a pro-active approach by CSOs in making contributions to

JLOS will be encouraged particularly in defending JLOS in situations where the ‘Rule of Law’ is under attack.

CSO involvement will also be achieved through attendance of the National JLOS Forum, the District/Regional Reviews and the Joint GoU-Donor review. Significant CSO contributions to the sector are also envisaged through innovative approaches for legal aid provision funded through the Legal Aid Basket Fund (LABF). Some of the specific areas for JLOS-CSO partnership include:

- Enhancement of community awareness of and involvement in JLOS
- Policy advocacy
- Advocacy for Law Reform
- Standard setting for instance in law enforcement
- Promotion of Independence of the Judiciary and fair trial guarantees
- Observation of recommendations to GoU from UN treaty processes such as presentation of country status reports

4.3.2 Private Sector:

The private sector stakeholders want and need to see progress that directly reduces the time and financial cost of doing business. JLOS will thus develop and implement effective strategies for involving and engaging private sector actors in the implementation and monitoring of SIP II. For the partnership to work effectively there is need for strong public/public and private/private partnerships hence enhanced synergies between JLOS institutions and JLOS and the private sector institutions.

JLOS will work closely with existing private sector apex organizations and or associations to identify, appoint and invite private sector representatives to all working groups with focus on the Commercial Justice Working Group. Examples are Private Sector Foundation of Uganda (PSFU), Uganda National Chamber of Commerce (UNCCI), Uganda Manufactures Association (UMA), Institute of Uganda Bankers, Uganda Insurers Association, Uganda Tourism Association (UTA) and Uganda National Farmers Federation (UNFF) and Federation of Uganda Employers (FUE) and the Association of Microfinance Institutions of Uganda (AMFIU).

JLOS will also build on existing mechanisms to seek input from other initiatives e.g. the Medium Term Competitiveness Strategy (MTCS), The Presidential Investors Round Table (PIRT) through its Regulatory Environment Committee, the Inter Institutional Trade Committee (IITC) and the Regulatory Best Practices Program.

Individual JLOS institutional working plans shall have mechanisms for creating private/ public partnerships alongside agreed principles and objectives that link into the overall JLOS goals. The dialogue will be structured and issues based to enable easier follow-up and avoid private sector meeting fatigue. The Commercial Court User’s Committee format, which has proved useful with its structured dialogue, will be extended to other institutions specifically, URSB, TAT and CADER and later to the criminal, land and family institutions on a pilot basis.

The partnership principles will agree on implementation mechanisms for agreed undertakings, define partnership objectives/expectations, accountability measures, agree on tools for routine consultation, as well as monitoring and evaluation to ensure periodic review of progress on achievements made. To that end JLOS will ensure adequate and effective private sector participation in its baseline surveys geared at gauging the impact and effectiveness of the reforms.

There is also need to create awareness about JLOS and to identify private sector champions to work with to build linkages between the private sector and its institutions. Overall dialogue will be structured, continuous and additive.

4.3.3 Enhancing Community Involvement

The JLOS institutions are on the supply side, providing services to the public while the public demands and utilises these services. In this regard, justice reforms can only be successfully implemented with the participation and engagement of the public in the various activities and processes of the justice sector e.g. as reporters of crime, witnesses in cases/ matters, enforcement of the laws, and JLOS seeks to enhance this participation through a rights based approach. JLOS SIP II also addresses key hindrances to public participation. These include; limited access to and awareness of JLOS institutions, ignorance of the law, their rights and obligations, and lack of structured mechanisms for JLOS engagement with these actors at national, regional and local level. The conflict in Northern Uganda has also severely limited public participation in JLOS whose physical presence is very limited in these areas.

In addition, the majority of people in Uganda are poor and require legal aid services which are largely provided by CSOs due to inability of JLOS to undertake its responsibilities. The public also primarily utilises the local council court system to settle disputes, however these courts too have limited capacity in terms of jurisdiction, awareness of laws and systems utilised. In this regard, the role of Ministry of Local Government as a member of JLOS must be exploited. Apart from advocacy for the enactment of the LC Courts Bill, other areas include consideration of a cost-effective capacity building model for the courts as well as an effective supervision mechanism.

SIP II will build upon interventions made under SIP I, by:

- developing user-friendly guides for JLOS institutions
- adopting a pluralistic approach to service delivery, that recognizes contributions of Legal Aid Services of CSOs
- establishment of user committees for the Commercial Court, CADER, URSB, TAT
- in collaboration with Ministry of Local Government, implement the recently passed LC Courts Bill to enhance performance of LC courts
- Phased support to capacity building of local council courts under the UNDP/UNCDF Programme.
- Development of a multi-pronged JLOS Publicity strategy
- Promotion of community policing and diversion

4.4 Key risks, Assumptions, and Sustainability Issues

In developing its implementation strategy, JLOS has taken into account critical factors that are necessary for the effective implementation of the reform programme. A number of underpinning factors lie beyond the scope of the sector but could never the less influence the accomplishment of the stated objectives and results. These factors have been captured and highlighted in the logical framework and include: the political will to support JLOS reforms, political interference in JLOS activities, institutional capacity, availability of human and financial resources, ongoing conflict in some parts of the country that may hamper implementation of activities, coordination and cooperation from other key actors (including the public, GoU institutions, CSOs and the private sector). In addition, one key issue is sustainability of reforms in the long term.

In identifying these risks, the Sector has made several assumptions and also developed strategies and proposed activities that will mitigate their effect. The commitment of the GoU and public to JLOS reforms is very critical to their success and JLOS will undertake a strong advocacy approach aimed at lobbying the political leadership for recognition, support and additional funding (e.g. through regular Cabinet Memos on sectoral reforms), the public and all key stakeholders (through an integrated publicity strategy aimed at enhancing public confidence and participation in the sector) and development partners (through continuous dialogue for coordination and funding).

JLOS will also continue to develop and strengthen intersectoral linkages so as to enhance its capacity and enable it achieve key results that are directly contributed to by other sectors and will also strengthen its linkages to ongoing reforms at the national level e.g. pay reforms and financial management reforms.

Key to this is the integration and imbedding of all reforms into the mainstream GoU processes and structures so as to ensure continuity and sustainability of reforms. JLOS has also outlined key strategies and activities needed for a smooth transition from SIP I to implementation of SIP II which will be utilised in the first year of the SIP II.

CHAPTER 5: PROGRAMME MANAGEMENT (STRUCTURES AND PROCESSES)

5.1 Programme Management (Structures and Processes)

In the implementation of SIP II, JLOS applies lessons from SIP I to strengthen its management structure and processes by:

- Revitalizing and reinvigorating essential structures that were less active in SIP I;
- Strengthening the capacity of the sector Secretariat to duly execute its mandate,
- Aligning working groups to the four focus areas (Land, Family, Commercial and Criminal);
- Streamlining parallel structures towards future full integration within JLOS processes;
- Working towards more effective and efficient management processes;
- Implementing Result Oriented Management (ROM) and Output Oriented Budgeting (OOB) strategies;
- Strengthening partnerships with development partners;
- Strengthening inter-sectoral linkages and collaboration by identifying and engaging into strategic and systematic collaboration with other sectors, independent government agencies, CSOs and the private sector; and
- Enhancing JLOS presence and visibility at district level.

5.2 The Management Structure

The management structure is reflected at two integrated levels - national and district. The structure continues to be based on a committee and working group arrangement that ensures participation and coordination of JLOS sector members, stakeholders and partners at both levels. The entire management structure is facilitated by the sector Secretariat.

5.2.1 JLOS at National Level

At national level, the structure comprises a Leadership Committee as the apex body, supported by a Steering Committee, Technical Committee, JLOS Coordination Committees (at district level) and working groups. Other entities within the structure include the JLOS Development Partner Group, the National JLOS Forum, as well as JLOS institutional Policy & Planning units (PPUs).

a) Leadership Committee (LC): Membership shall consist of:

- Chief Justice (chair),
- Minister of Justice and Constitutional Affairs,
- Minister of Internal Affairs;
- Minister of Finance, Planning and Economic Development;
- Chairpersons of Uganda Law Reform Commission and Judicial Service Commission;
- Chairperson of the JLOS Steering Committee; and

- Head of JLOS Secretariat

The LC may invite other key stakeholders as deemed necessary to the meetings including the Minister of Public Service, the Minister of Local Government, Minister of Gender, Labour and Social Development and the Principal Judge.

Key responsibilities:

- Overall political leadership
- JLOS representation at Cabinet & Parliament levels to effectively lobby for the benefit of the sector by articulating JLOS issues and raising the JLOS profile.
- Policy formulation and direction for the sector

Meetings of the LC are to be invoked by the Steering Committee through the sector Secretariat, as and when deemed necessary, but in principle, when there is a need for either policy guidance to the sector, or to reinforce the sector objectives.

b) Steering Committee (SC): The Steering Committee will comprise:

- Heads of the JLOS institutions - Police, Prisons, DPP;
- Permanent Secretaries (MoIA, MoGLSD, MoLG, MoJCA- SG, ULRC, JSC, Judiciary-Secretary to the Judiciary, Chief Registrar);
- Permanent Secretaries (MoFPED (PS/ST), MoPS, OPM);
- Chairperson of the JLOS Technical Committee; and
- Head of JLOS Secretariat

Key responsibilities:

- Oversee implementation of SIP II;
- Management decision-making;
- Reflection and strategic guidance to the reform process; and
- Giving direction to the reform process.
- Policy decision

The chair of the SC will be the Solicitor General while the Senior Technical Advisor (STA) shall be Secretary to the SC. Meetings of the SC will be held quarterly or as and when deemed necessary by the Chairperson. There will be collective responsibility for decisions taken at these meetings.

c) Technical Committee (TC): The Technical Committee will comprise technical personnel from the JLOS institutions at Under-Secretary/Commissioner-level or heads of departments. There will be one representative from each of the JLOS institutions, with one alternate designated by each institution. (*Only one member from each institution shall attend at a time*). Other representatives shall include:

- Chairpersons of the Working Groups (if not already represented as technical heads)
- The Senior Technical Advisor, the financial Management Specialist and Technical Advisors from the sector Secretariat;
- Chairperson of the Chain Linked Initiative Technical Committee;
- JLOS Desk officers at MoFPED and MoPS; and

- Institution-based Technical Advisors under bilateral project arrangements, as relevant and determined by the host institutions.

Key responsibilities:

- Review the SIP II strategy annually and break it down for the year;
- Ensure implementation of SIP II;
- Track and monitor progress of SIP II implementation;
- Tasking each of the five Working Groups to identify sectoral problems and solutions related to their focus area, and across all KRAs;
- Troubleshoot, report to and advise the SC on SIP II implementation;
- Providing the primary link between individual institutions and the sector as a whole.
- Sector publicity in close collaboration with the sector secretariat;

The chair of the TC and an alternate chair, will be rotated annually, rotating amongst JLOS sector institutions. One of the Technical Advisors from the sector Secretariat will be designated as Secretary. Meetings of the Technical Committee will be held once in two months and as deemed necessary, focussing on impact rather than procedural matters only. There will be collective responsibility for decisions taken at these meetings.

d) Working Groups (WGs): The Technical Committee will largely operate through five WGs, four of which will cover the four Focus Areas (Land, Family, Commercial and Criminal justice), with the fifth as a functional WG for Budget/Finance. This group carries over its role from SIP I, which is to develop financial components of the programme, and to liaise with MoFPED. It is noteworthy that discussions in the WGs will be around the KRAs.

The chair of each WG will be determined annually by members of each WG, being selected on a rotational basis from amongst Technical Committee members within the WG. He/she shall have an alternate chairperson to take over if necessary. Membership will be selected as follows:

- To the extent possible, each JLOS institution will nominate at least two suitable representatives to each WG. One will be a senior technical person and the other, the head/or a representative from the Policy and Planning Unit;
- The sector in consultation with CSOs and private sector bodies will nominate suitable participants to the WG(s) deemed relevant (*for details see Annex on WG composition*).
- The Budget/Finance WG will comprise of financial representatives at Under Secretary/ Accounting Officer level. The Financial Management Specialist (FMS) who will take the role of secretary and a representative from the JLOS Donor Group will also comprise members of this WG.
- Representatives from the associate institutions (LDC, TAT, ULS, CADER to relevant WGs) and the Office of the Prime Minister (OPM);
- The two Technical Advisors in the Secretariat will each sit on two WGs and act as secretaries to the WGs.

Key Responsibilities (see Annex for details on each Working Group):

- Carry out delegated role of TC;
- Maintain focus on pro-poor, low cost initiatives, vulnerable groups, conflict/ post-conflict affected areas;
- Monitor and evaluate progress of JLOS sector work plans towards achievement of sector-wide objectives;
- Recommend relevant changes to SIP II implementation activities, as necessary;
- Respond to issues raised by the TC, SC and LC;
- Continually seek to mainstream cross-cutting issues in all activities (Poverty, Gender, Conflict, HIV-AIDS, Environment);
- Benchmark JLOS against other successful sectors/models;
- Lobby MoFPED for better funding of the sector (specific to Budget WG); and
- Develop annual work plans and budgets (specific to Budget WG);

The WGs will meet **twice-monthly** or when necessary, but at least once a month.

e) The JLOS Secretariat

Within the course of SIP II, JLOS will work towards integrating the Secretariat into the Civil Service structure. The pace of growth of the secretariat will be in tandem with developments in the sector as well as resource availability. The Secretariat will provide the vital link to all the Working Groups and Committees in the Sector. Staffing includes:

- Senior Technical Advisor (STA) (reporting line to the chair of the SC);
- Financial Management Specialist (reporting to the STA);
- Two Technical Advisors (previously Resource persons), each responsible for two focus areas (Criminal & Family, and Commercial & Land) and reporting to the STA;
- Two policy analysts from the MoJCA PPU;
- Four Support Staff;
- Secondments from institutional PPUs;
- Short-term technical assistance will be taken on by the sector Secretariat as needs dictate in the course of SIP II implementation. Key areas already identified include M&E and mainstreaming of cross-cutting issues including gender.

Key responsibilities: Operational leadership, research, sector wide M&E, policy development, communication, liaison & coordination, public relations, financial management. (See Annex for TOR of the sector Secretariat.)

f) Institutional Policy & Planning Units (PPUs)

Under SIP II, the sector will focus on establishment of PPUs that are not yet in place and strengthening capacity of all PPUs. Linkages between PPUs and other institutional departments and with the Sector Secretariat which will work closely with institutional PPUs will also be strengthened. **Key responsibilities** will include:

- Policy analysis;
- Liaising with institutional representatives to collect and analyse data;

- Monitoring progress towards achievement of indicators at institutional and sectoral levels
- Providing monitoring information to the WGs;
- Representation of institutions at WG.

In addition, regular meetings will be held between institutional PPU members and the JLOS Secretariat team at least once every two months. These meetings will be specific issues based and called by the Senior Technical Advisor, with the aim of building capacity in the Secretariat, monitoring progress, encouraging idea-generation and sharing of experiences.

Key Responsibilities: Research, policy analysis, internal M&E, liaison & coordination. (See Annex for TOR of PPUs)

5.2.2 JLOS at Community/ District Level

At the community level JLOS is represented by the **JLOS Coordination Committee (JCC)** based in each district with the objective to oversee & coordinate improvements in administration of justice and maintenance of law and order, primarily aimed at enhancing case management and reducing case backlog. The JCC comprises the existing multitude of JLOS committees at the district level (including the Chain Linked Initiative and the Community Service Committees). However, the existing District Community Service Committee established by Statute will remain. The JCC will comprise the following members:

- All JLOS institution representatives at district level
- District Probation & Social Welfare officers, as representatives of Juvenile Justice Child Welfare committees;
- Uganda Law Society Representatives;
- Relevant CSOs and private sector organisations;
- Civic and local leaders;
- Nominated members of the Public (including Fit Persons under the Juvenile Justice programme)

The JCC will be chaired by Chief Magistrate (or Magistrate Grade 1 as appropriate) and will meet **monthly**. Quarterly meeting reports will be sent to the Technical Committee through the sector Secretariat, utilizing the existing strong feedback links between the Chain linked Initiative Technical Committee. Feedback to the JCC from the Leadership or Steering Committees will largely be through the Secretariat while at the district, the JCC chair will give regular briefs and updates to the Resident Judge. The regional/district reviews (see below) also give opportunity for feedback.

5.2.3 The JLOS Development Partners Group

The JLOS Development Partners Group (J/DPG) is comprised of agencies that support JLOS through various mechanisms including general budget support, sector budget support and project support. The group has a membership of Austria, Denmark, EU, Germany, Ireland, Netherlands, Norway, Sweden, UNDP/UNCDF, United Kingdom

(represented by Netherlands) and the World Bank. The J/DPG has linkages to the broader Development Partner community through the Local Development Partner Group, and hence to the Donor Economist Group.

The J/DPG holds **monthly meetings** enabling representatives to keep pace with JLOS developments, coordinate amongst themselves and with JLOS. The chair of the group rotates between members, on an annual basis.

The relationship between the J/DPG and the sector is based on the general GoU-Donor Partnership Principles 2003 under MoFPED. On the basis of the partnership principles, JLOS and the J/DPG have developed collaboration and co-ordination mechanisms to ensure effective contribution of the latter to the reform process. These comprise:

- Development Partners sub-group monthly meetings ;
- GoU- Development Partners Liaison Group meetings ;
- Joint GoU- Development Partners Reviews;
- Joint GoU- Development Partners pre-review Technical Meetings;
- Participation in the broad-based JLOS Forum, held annually;
- Participation of existing technical advisors in the Technical committee; and
- Development Partner – institutional partnerships.

5.3 Management Processes

Key management processes include the JLOS Forum, programme management carried out by the Secretariat, meetings of the various committees in the management structure, the coordination and communication between JLOS management structures and the Joint GOU- Development Partner Review (*see Figure 3 overleaf*).

5.3.1 Programme Management Activities: These include all the activities that have to be undertaken by the Secretariat that is responsible for facilitation of the entire management structure in order to invigorate and sustain the reform process. Based on the TORs of the Secretariat, these activities fall within a wide bracket of management functions including planning, budgeting, monitoring, coordination and liaison, technical backstopping and reporting.

5.3.2 The National JLOS Forum: This will now take the form of an annual event, taking place in December. The Forum will bring together JLOS members and key stakeholders to reflect on JLOS performance for the year ending as well as indicate priorities for the one ahead. The National JLOS Forum will:

- Provide a platform to share information with the invited guests & the public, and to raise issues on access to justice pertinent to all stakeholders;
- Provide a platform to benchmark national leaders and the Public;
- Enable JLOS show case its successes, explain its constraints and reflect its performance as mirrored against stakeholders expectations;
- Enable JLOS highlight priorities for the year ahead;

5.3.2 The Joint GOU-Development Partner Review: The joint review will be held annually in June to monitor progress against planned activities. Participants will include JLOS members and invited stakeholders. Preparation for and reporting on the JLOS Forum and the reviews will be coordinated by the sector Secretariat, in the context of twice-yearly technical meetings with the Technical Committee including institutional PPU's and the JLOS Development Partners Group. *(See Annex for ToR of J/DPG)*

5.3.4 JLOS Regional/District Reviews: these will be held annually in selected regions/districts of the country to enhance planning, implementation and monitoring of the SIP II and obtain feedback for the national reviews. The Technical Committee with support of the Secretariat will liaise with the JCC at the district level to hold these reviews which will involve JLOS institutional representatives at the district/regional levels, CSOs, Private Sector and members of the Public.

5.3.5 Joint Leadership and Steering Committee Meetings: These joint meetings will be carried at least once a year to strengthen the process of policy formulation and discussion and to foster linkages between the two committees. Meetings will be convened by the Chair of the SC.

5.3.6 JLOS- Development Partner Technical Meetings- these joint meetings will be held twice a year (in December and June before the annual review) to enable detailed discussion of the six monthly sector progress reports and preparation for the Review.

5.3.7 Regular Committee Meetings: As indicated above, the various entities in the management structure will conduct their business through meetings, the majority of which are to be convened on a regular basis.

Figure 3: JLOS structures and management information flows

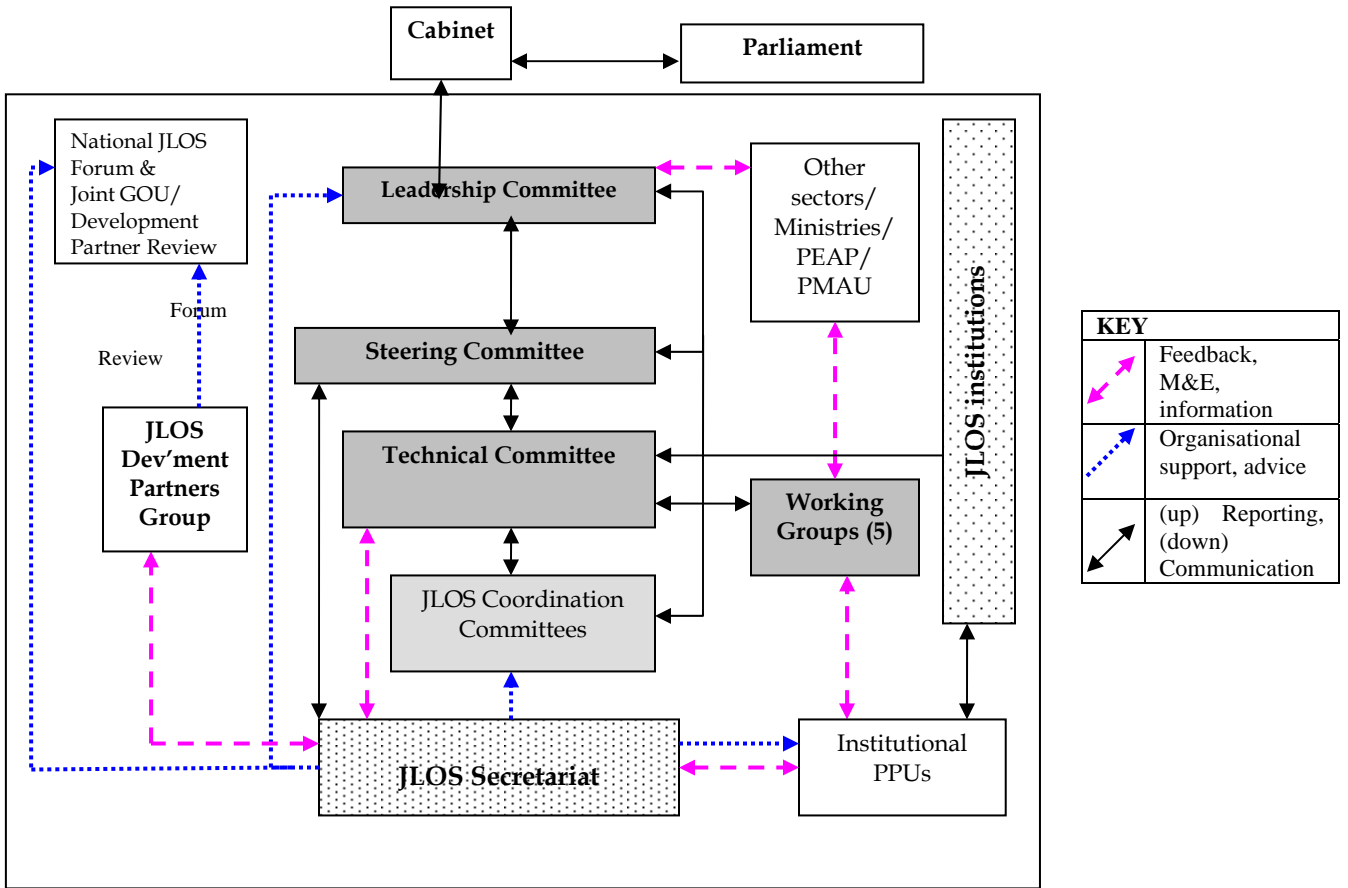

CHAPTER 6: MONITORING AND EVALUATION

6.1 Introduction:

In order to monitor progress towards attainment of stated goals and ensure successful implementation of activities, JLOS has initiated the process of developing an M&E framework that will be further developed under SIP II. The JLOS log-frame (*see Annex A*) provides the basic M&E framework with sector wide indicators that provide the essential tools for carrying out the M&E activities. The process of strengthening the performance indicators (both sectoral and institutional) with established baselines and targets; integrate existing Management Information Systems (MIS); ensure clear linkage to the intended programme outputs; determine and strengthen adequacy of means of verification and ensure that all indicators are objectively verifiable will continue under SIP II.

JLOS needs a strong emphasis on evidence-based decision making in order to ensure:

- A rational case for resource allocation;
- An assessment of impact – particularly in relation to the JLOS contribution to PEAP;
- Motivation of JLOS staff;
- Sufficient flow of information to the Uganda public in order to stimulate the 'demand side' related to JLOS reform initiatives;
- Sufficient flow of information to development partners that encourages continued support for the sector.

At the commencement of SIP II, the sector will develop input, process and output indicators at institutional level in alignment with the existing outcome/impact indicators at sectoral level. Monitoring of cross cutting issues and priority themes of relevance including gender, HIV/ AIDS, poverty, conflict, governance will be mainstreamed through disaggregation of performance indicators by age, geographical location, gender, and socio- economic status.

Data collection systems will be reviewed and revised to enable the collection of relevant data while M&E responsibilities at institutional and sectoral level will be streamlined.

The JLOS M&E framework will from the onset be linked to the National Integrated Monitoring and Evaluation System (NIMES) under the Office of the Prime Minister so as to enable tracking of progress and JLOS contribution to the PEAP.

6.2 M&E Gaps in JLOS

A number of challenges have affected the efficient operation of M&E:

- Limited capacity in the JLOS Secretariat and institutional Policy and Planning Units
- Inadequate public feedback both at local and national level – The District Access to Justice Committees were supposed to feed local responses and concerns into JLOS

progress reports at local level were never established. At the national level, the National JLOS Forum was only held in 2005.

- Overlapping reporting systems: including separate management structures and separate reporting mechanisms for projects which led to an overlap in membership of committees and confusion in reporting. The information on the progress of these projects was not systematically reflected in JLOS planning and reporting.
- Inappropriate indicators: The indicators selected for SIP, I were not 'sector-wide' - rather, they focused on discrete areas where performance was expected to improve.
- Insufficient user surveys: The two baseline user surveys carried out at the start of SIP-I (Criminal and Commercial) made a substantial contribution to the design of monitoring indicators for the two programmes. 'Random user studies' were not carried out.
- Institution - based reporting: Progress reporting tended to focus on activities at the institutional level rather than on impacts at the sectoral level.
- Information flow between the sector and the institutions is not harmonised
- Ineffective and under-utilised complaints mechanisms: The web of official complaints mechanisms regarding JLOS is 'highly fragmented' and the information generated is not used by JLOS as part of its M&E.
- Existing MIS and case management systems are not integrated and operate in isolation.

6.3 The National M&E Framework:

Within the context of the PEAP, an overarching plan for M&E was envisaged in the Poverty Monitoring and Evaluation Strategy (PMES) as developed in 2001. The PMES has since been replaced by the emerging National Integrated M&E Strategy (NIMES) with a secretariat in the Office of the Prime Minister. Its crucial instrument is the PEAP Results and Policy Matrix, which contains output and outcome indicators related to all the PEAP strategic objectives. Data will be collected using a variety of methods including censuses and surveys; administrative data, most of which will be generated by the local governments and coordinated through the Local Government Information & Communication System (LOGICS) developed by the Ministry of Local Government - allowing sector-specific information systems to 'talk to each other'; Sectoral data from sector-specific MIS - including JLOS; and Participatory Poverty Assessments (PPAs).

The existing routine reports that feed into NIMES are The Poverty Status Report (PSR), which is produced every two years by MoFPED; PEAP Progress Report (produced every other year, in between the PRS; and Sectoral Joint Review Reports, produced every six months. The main output of NIMES will be the *National Policy and Programme Performance Status Report* produced every six months.

The JLOS/SIP-II M&E system, has formulated indicators that are in harmony with the PEAP Policy and Results Matrix and will continuously align its reporting mechanisms with those envisaged by NIMES.

6.4 The JLOS M&E Framework:

The M&E framework addresses the key challenges raised in SIP I and will ensure that all JLOS institutions are integral components of the system and that individual institutional issues that are cross-cutting will be adequately addressed. The framework will maintain linkages to local level forums and sustain public feedback mechanisms, particularly through district/regional reviews and JLOS Coordination Committees. At the national level, through the Annual reviews and National JLOS Forum, there will be an opportunity to receive and assess feedback on JLOS policy priorities and programme implementation from civil society, the private sector, other government sectors and development partners.

The JLOS logframe provides the basic M&E framework – and its indicators provide the essential tools for carrying out the M&E activities. The priority indicators are the outcome or impact indicators – designed to measure the quantity and quality of the envisaged results from the SIP, II programmes in the medium term. These are reflected at the purpose level and are therefore related to such aspects as increased public awareness about rights and duties, and improved confidence in JLOS institutions.

Indicators have also been developed linked to each Key Result Area. As activities are developed and clustered in institution and cross-institution work plans, then other indicators will be formulated at institutional level to measure the efficiency and effectiveness of activity implementation. These will be categorised as input, process and output indicators.

The routine progress report will focus on the input, process and output indicators – and they will also address the progress being made in relation to the impact indicators. The reviews and evaluations will focus mainly on the impact indicators – on the extent to which SIP, II is achieving its objectives.

Priority Actions under SIP II include:

- Establishing baselines through a JLOS wide baseline and follow-up survey which will also enable the sector to review the proposed indicators and set targets;
- Improving/standardising data collection formats and register across the sector;
- Improving record keeping through training of records staff and computerisation;
- Linking institutional Management Information Systems and Case Management Systems across the sector;
- Reviewing management structures from local to the national level to facilitate structured inputs from the public and from advocacy groups;
- Enhancing analysis and use of existing data among management for decision making and policy formulation;
- Conducting regular/periodic surveys to gauge user perceptions and experiences and track changes
- Developing and implementing a dissemination strategy for reports generated.

6.5 JLOS Monitoring and Programme Management Cycle over SIP II:

The M&E framework will be integrated into the SIP II programme management cycle (see Chapter 5). An integrated approach bringing on board the participation of civil society, private sector and other stakeholders will enhance the functioning of the programme. Main features include:

6.5.1 Key Data Sources:

The Sector will utilise existing and improved data sources including institutional reports, administrative data, national data sources, and national and international surveys. The Sector will replace reform component surveys under SIP I with **JLOS-wide surveys** to specifically establish sectoral baseline information on the sector-wide indicators to be repeated **every three years** as a follow-up on progress. Innovative low cost data sources will be explored including user conferences and targeted and issue based research, and CSO reports.

The Sector will also enhance linkages and draw synergy from the existing national monitoring framework and systems for instance the Uganda Human Rights Report, the National Service Delivery Survey, the Uganda Poverty Participatory Assessment and the emerging National Integrated Monitoring and Evaluation Systems (NIMES) to monitor programme progress as reflected in the Logical Framework.

6.5.2 Data Collection, Processing, Analysis

The JLOS Secretariat, in close liaison with the PPU's in the JLOS institutions, will institute a regular data collection process to meet the requirements of the various committees. Existing information from the institutions (as collected and analysed from the local/regional levels) will be reviewed in order to identify sector-relevant issues that should be addressed and to produce the half-yearly sector reports.

a) JLOS will improve and standardise its data collection formats across the sector to ensure data collected meets agreed parameters and feeds into the performance tracking mechanism. Support of key research and monitoring agencies such as Centre for Basic Research and Makerere Institute of Social Research will be sought in this process.

b) Management Information Systems (MIS) and Case Management Systems (CMS): JLOS will also utilise and strengthen existing CMS to collect, process information in the sector while also strengthening MIS to improve analysis of this information which should form a strong basis for management and policy decisions in the Sector.

c) Regional/ district reviews will be held annually to enhance monitoring of progress at the local level and these will culminate into the JLOS annual review in June.

d) Joint inspections: the regional reviews will be complemented with joint inspections and institutional visits conducted by the Secretariat, PPU's and representatives of the

JLOS Development Partners Group. These will further be informed by reports from institution specific monitoring and inspectorate mechanisms.

6.5.3 JLOS Reporting System

Institutional reports will form the basis of tracking achievement and JLOS will develop a standardised reporting method across all the JLOS institutions. Periodic progress reports will be submitted half yearly and these will form the discussion basis for the Joint GoU-Donor Technical Meetings before the semi-annual Joint GoU-Donor review.

The reporting will be centred on the five key result areas and the five monitoring themes of *relevance, efficiency, effectiveness, impact and sustainability* will be used.

The JLOS will develop and implement a dissemination strategy to ensure that JLOS reports are received and utilised to influence implementation practice and management.

6.6 M&E Roles and Responsibilities

The Secretariat in collaboration with the institutional PPU's will manage the sector wide M&E function. At the commencement of SIP II, they will map information needs and standards, availability and adequacy of information required, frequency, flow and format for reporting plus feedback to realign, plug gaps in data sources and coordinate institutional M&E systems to the sectoral monitoring requirements. The Sector Secretariat shall also ensure the integration of sectoral M&E systems into the National Integrated M&E Strategy (NIMES).

The Sector Secretariat staffing will be strengthened with the recruitment of an M&E Specialist who will liaise with institutional PPU's to monitor sector reforms (*see TORs in Annex*). The table below details the responsibilities of the various JLOS structures.

Table 5: M&E Responsibilities in the Various JLOS Structures

Group	M&E Functions
National JLOS Forum	The public arena: <ul style="list-style-type: none"> • Informing the public about the performance, problems and potentials of the sector; • Receiving feedback from civil society, the private sector and the development partners who support JLOS.
Leadership Committee	In the political arena: <ul style="list-style-type: none"> • Receiving reports submitted by the Steering and Technical Committees, and from consultations in various national forums; • Providing political direction to the programme; • Making representations on behalf of JLOS at Cabinet level, parliament and with the Public.
Steering Committee	In the policy-making arena: <ul style="list-style-type: none"> • Receiving reports from the Technical Committee; • Considering impact issues related to the SIP-II objectives and key result areas; • Taking responsibility for evidence based policy making and considering policy decisions related to adjustments of SIP-II.

Group	M&E Functions
Technical Committee	In the implementation arena: <ul style="list-style-type: none"> • Based on objectives and key result areas of the SIP-II – and reports from the working groups – reflecting on general strategic issues; • Determining action plan priorities; • Ensuring the SIP-II programme is achieving its stated Purpose and Goal.
Working Groups	Related to the four Focus areas (commercial, land, family and criminal): <ul style="list-style-type: none"> • Monitoring progress of JLOS sector work plans towards sector-wide objectives within the focus area of a particular Working Group; • Producing reports on result area issues for consideration by the Technical Committee.
Policy and Planning Units	At the institutional and sectoral level: <ul style="list-style-type: none"> • Gathering and analysing information on progress of institutional work plans – which should be linked to sectoral plans; • Preparing progress reports • Liaising with the sector Secretariat
JLOS Coordination Committees	Based on their day-to-day work (related to case management): <ul style="list-style-type: none"> • Generating information at the district level concerning implementation constraints and challenges; • Feeding local responses and concerns into JLOS progress reports.
JLOS Secretariat	At the sectoral level: <ul style="list-style-type: none"> • Refining M&E framework; • Carrying out day-to-day monitoring of SIP-II; • Gathering reports from the working groups, institutional PPU's; • Compiling reports for the hierarchy of JLOS committees and the six monthly reviews.
JLOS Development Partner Group	In relation to support for the sector: <ul style="list-style-type: none"> • Highlighting contextual issues affecting JLOS; • Reaffirming GoU and donor commitment to JLOS; • Providing a linkage to other sectors; • Participating in institutional and field visits and joint reviews

6.7 Reviews and Evaluations

The sector will hold a two-day Joint JLOS GoU-Donor annual review in June to monitor progress. In December, the **Annual National JLOS Forum** stretched over 3-5 days will also be held. Key stakeholders (e.g. UHRC, DEI, IGG, other sectors, district representation, the public) will be invited to participate in evaluating JLOS activities and setting priorities.

The JLOS Secretariat in liaison with the institutional PPU's will have the responsibility, for producing the two semi-annual reports that will inform two pre-review meetings.

The SIP, II will be subjected to two independent evaluation exercises: a Mid-Term Evaluation at the end of the third year of operation and an end term Evaluation at the end of the five year period in 2010/11. The terms of reference for the external evaluations will be drawn up by the Secretariat in close liaison with the Technical Committee and JLOS Development Partners.

CHAPTER 7: FINANCING THE REFORM PROCESS

7.1 MTEF and Affordability analysis:

7.1.1 The National Budget of Uganda is allocated to sectors through the Medium Term Expenditure Framework (MTEF) which is a three year rolling framework for planning, budgeting and expenditure. The challenge facing the JLOS sector is the competition for limited recurrent and development funds in Uganda. Each year the MTEF is revised and from that the National Budget Framework Paper (BFP) for financial years 2005/06 to 2007/08 sets out the fiscal policy framework and budget strategy. The extent to which JLOS and its individual institutions can increase or maintain their 'share' of that budget relies on demonstrating how actions performed by the sector serve national priorities as highlighted under the PEAP 2004. The planning period budget below therefore encapsulates the issues which have underpinned the medium term objectives of the JLOS. In addition and through the application of the tools and methodologies of the Ministry of Finance, Planning and Economic Development (MoFPED), the Sector analyses its budget and points to a funding gap that will form the basis of interface between the Sector leadership along with its partners and the MoFPED.

The national budget over the medium term and itemised between sources, is as follows:

Table 6: Itemised National Budget

Shs Billion	MTEF 2005/06	MTEF 2006/07	MTEF 2007/08
URA Revenue	2,200	2,461	2,736
Non URA	57	58	72
Total GoU	2,257	2,519	2,808
Budget Support	839	820	754
Project Support	1,016	910	348
Total Donor	1,855	1,730	1,102
Total Inflow	4,112	4,249	3,910
JLOS (Rec & Devt)	182	178	190
JLOS Development budget	35	30	39

The PEAP 2004 highlights an increasing marginal share of resources for JLOS from current levels despite a reducing percentage share for the sector over the long term. The Ministry of Finance has made it clear in several sector discussions that project aid is not welcome and that budget support is preferred in grant form. Loans would only be considered as a last resort, and then only in the context of a costed, prioritised sectoral plan with clear links to PEAP objectives. The challenge for JLOS, as demonstrated through this SIP II, is the direct link between the activities that JLOS institutions will undertake and the PEAP and National Budget priorities of Government.

During the planning period, the JLOS share of the national budget is illustrated below;
Table 7: Provisional Sector Shares 2003/4 and 2013/14

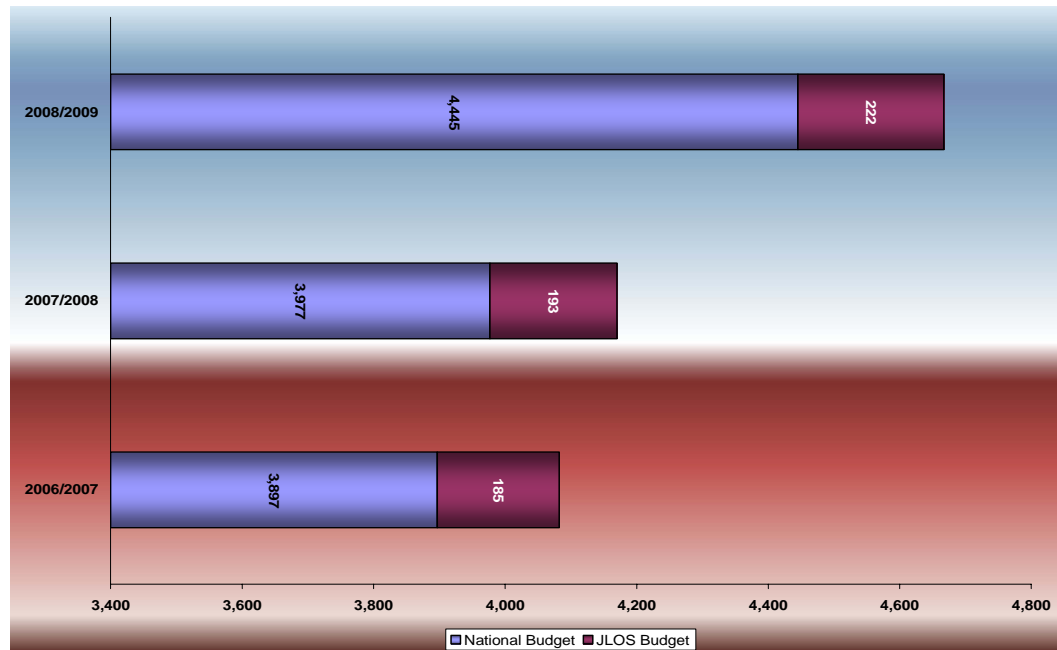

Source: MTEF Figures

7.2 Key Financial Challenges under SIP II

Key financial challenges envisaged under SIP II include:

- Rationalisation of the intended investment under SIP II within a diminishing recurrent budget (see Illustration 8)
- Inclusion of non- JLOS activities including LDUs, local militias and the integration of ex-combatants and channelling of their budget through JLOS leading to an artificial raise in the JLOS budget
- Closing the funding gap of Ug Shs 9,768,600,000 over the period (See Table 8)

In addition the Sector takes particular cognisance of a number of key financial challenges highlighted by the Medium Term Evaluation (2004) as affecting implementation of programmes and these included:

- Low budgetary outturns due to external national budgetary shocks - until FY 2004/05, only the Case Backlog Project was protected from Budget cuts under the Poverty Action Fund.
- Low institutional absorption capacity
- Limited rationalisation of budgets leading to resource inefficiency
- Limited internal support for a sectoral approach
- Inadequate Financial Management Systems
- Admission of projects not originally prioritised under SIP I

Table 8: JLOS SIP II Funding Gap over the planning period

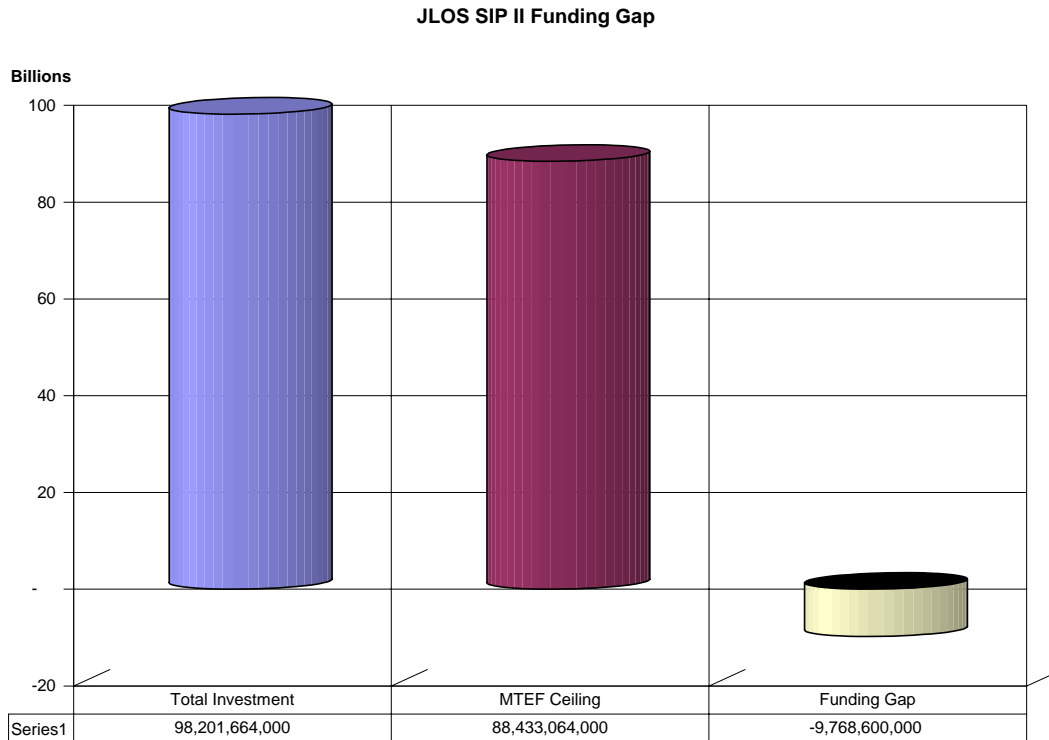

Progress has since been attained on a number of challenges above including;

- Extension of PAF protection to the entire basket fund resulting into outturns unaffected by external shocks to the sector.
- Recruitment of a Specialist within the JLOS Secretariat to implement the Financial Management Strategy aimed at improving budgeting, revenue generation, expenditure and financial accountability within the Sector

In addition and in response to the above highlighted challenges the Sector has adopted the following positions to enhance the management of finances in line with the national guidelines and in support of the overall Sectoral objectives

- The Sector will progressively move towards a unified sector wide investment budget so as to rationalise institutional and Sectoral development budgets
- A minimum of 30% of the JLOS Development Investment in the Medium term will target service delivery in conflict and post conflict affected areas
- The Sector shall operate one basket fund account to reflect the integration of components under SIP II.
- The Sector shall adopt a pro active approach to expand the JLOS Resource envelope through prioritization of low cost innovations and increased generation and better management of Non Tax Revenue, Realization of Internal Efficiency Gains, Strategic alliances with CSOs, Local Governments and Private Sector and active participation in ongoing national initiatives to reduce fiduciary risk in the Sector.

Table 9: JLOS resource envelope in Billions

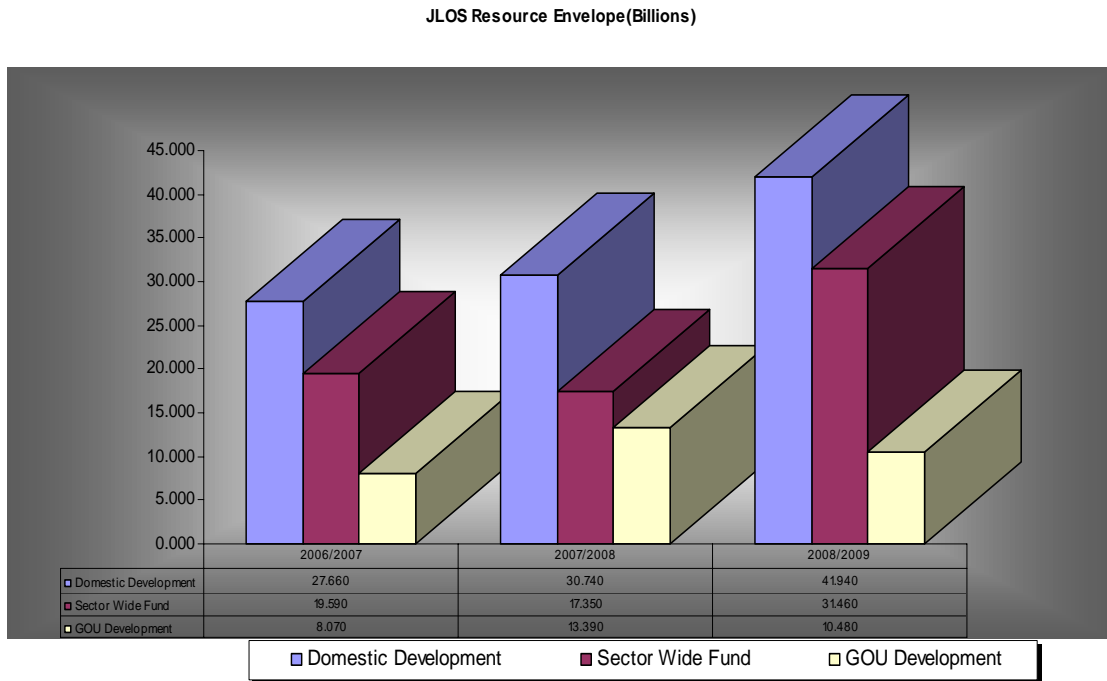

7.3 Low Cost Initiatives and Non Tax Revenue

In light of limited resources, reducing % share of budget, JLOS will enhance its operations by undertaking budget control measures from within. The sector will continue to identify and develop policies and strategies aimed at reducing costs and identifying low cost initiatives. Some cost cutting and innovative strategies that have been identified include:

- Review of utility payments mechanisms and processes e.g. for Renting vis a vis owning structures, payment of Utilities e.g. water, telephones, electricity and develop efficiency saving measures at institutional level;
- Harmonisation of allowances paid to different committees at national and local level
- Prisons farms- management and commercialisation of farms (under private management);
- Prisons- use of solar energy sun ovens in preparation of food for prisoners;
- Identification and implementation of low cost initiatives at institutional level.

In addition, several of the JLOS institutions have sources of non-tax revenue. In developing the Budget Framework Paper for 2006/07, and forecasts for 2007/08 and 2008/09 the non-tax revenue as a source of funding, and a contribution to the institutions has been considered within the overall MTEF. The sector will undertake a sustained lobbying effort to retain a percentage share of collected Non Tax Revenue as appropriation in aid to sustain programmes. Some examples of Non Tax Revenue generated include:

- (a) The Ministry of Justice and Constitutional Affairs (collecting Shs 800 million in 2004/05), largely from the Registrar of Companies and Patent Fees
- (b) The Ministry of Internal Affairs (collecting Shs 4 billion) from immigration operations, representing 72% of the income budget, compared to an expenditure budget of Shs 24 billion
- (c) Police Force (collecting Shs 2 billion), over half from providing security to government officials, and with an expenditure budget for the institution of Shs 75 billion.
- (d) Prison (farms) collected Shs 600 million, only 24% of the budgeted income
- (e) Commercial court recently published Commercial Court Case Reports 1997- 2001 and intends to sell with the possibility of retaining income to sustain the courts activities.

These performances of non-tax revenue and comparison to the expenditure of the departments to which they are attributed suggests that the greatest emphasis remains on raising efficiency of staff employed in institutions – as identified in the Public Sector Reform Policy – and reducing costs incurred in generating own income.

The SIP II is continuing the transition begun in SIP I towards sector wide goal identification and budget focusing. The non-wage recurrent expenditure has been considered fixed in the short term, with obligations for operational costs of the offices, allowances, stationary and travel dominating the resources. The responsibility for ensuring efficient use of these recurrent non-wage costs, as well as the completion and deployment of the approved establishment has remained with the relevant Accounting Officer. They have undertaken to ensure that priorities of the Development Budget which have a recurrent cost impact will be adequately served. The non-tax income sources will not, therefore, be changed in the course of the SIP II.

7.4 Financial Management and Procedures

The Ministry of Finance, Planning and Economic Development has developed the Financial Management Strategy and is continuing to implement the Integrated Financial Management System (IFMS) which has been rolled out to some Ministries as well as to Local Governments. However, the accounting procedures of Government do not in themselves ensure robust financial management within emerging sector wide approaches.

The SIP II seeks to reduce these barriers of compartmentalised planning with sector-wide priorities and the Financial Management Specialist will revise the Financial Management Strategy to this end. The FMS will work with the Accounting Officers in the JLOS institutions and through the Budget Working Group to enhance performance, accountability and value for money in the sector.

At institutional level, Contracts Committees will prepare specifications for tenders and the SIP II annual planning will be strengthened by the undertaking of the institutions to ensure that capital expenditure is supported with the requisite recurrent cost necessary

to operate or sustain that asset/investment - and establishment waged staff are available to populate it.

7.5 Budget for 2006/07 and the SIP II period

7.5.1 The overview of the BFP for 2006/07- 2008/9 is indicated in Table 10 below and shows a slightly higher amount in the first year (37% of the total resource envelope over the 3 years) as compared to the other two years in the planning period. This is largely aimed at catering for ongoing infrastructural programmes such as construction of the Commercial Court and existing projects such as the Strengthening of the Judiciary Project.

Table 10: Funding by years in JLOS SIP II

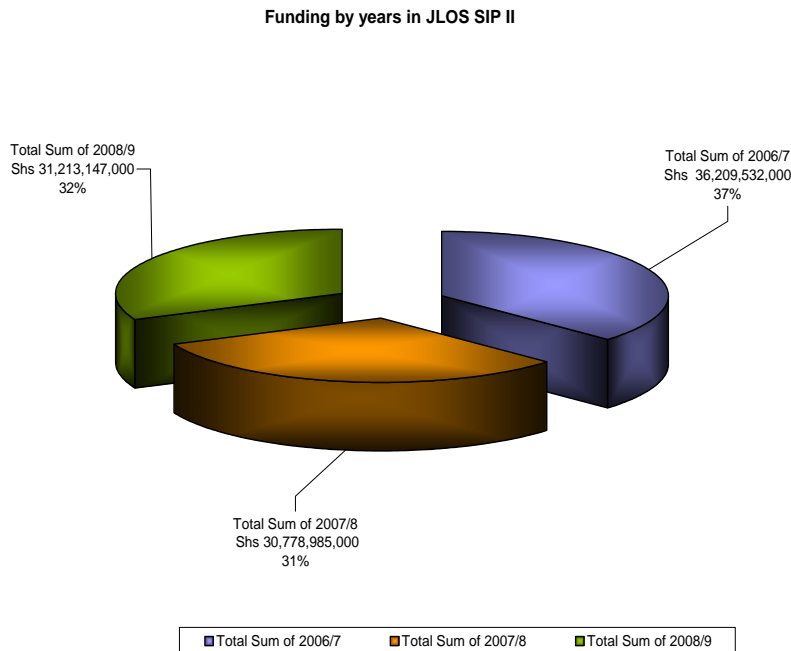

7.5.2 Funding is further broken down by Key Result Area as shown in Table 11 below and indicates a relatively large percentage of resources earmarked for Key Result Area on enhancing Access to Justice for vulnerable and marginalised groups. However, the strong link between the sector Key Result Areas means that investments from a budget allocation under one Key Result Area will bear impact on improvements in another Key Result Area.

Table 11: JLOS SIP II Budget is further broken down by Key Result Areas and by years

JLOS SIP II Budget by KRAs by Years

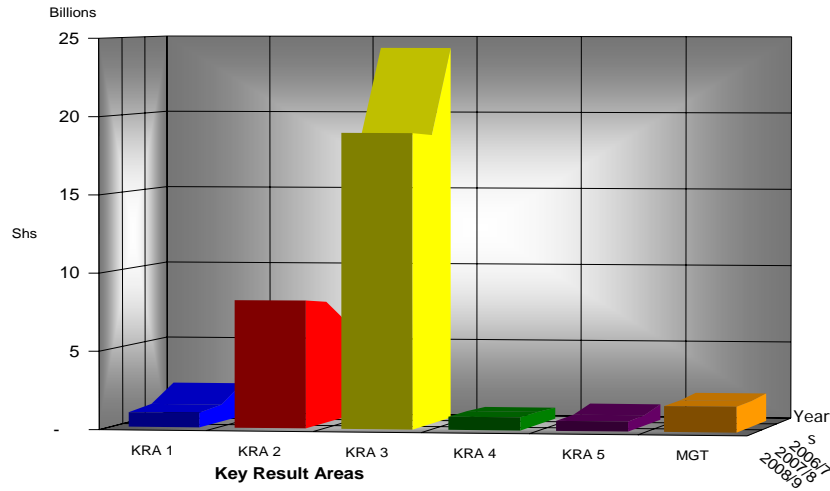

	2006/7	2007/8	2008/9
KRA 1	2,149,500,000	1,105,000,000	940,000,000
KRA 2	6,283,266,000	7,848,266,000	8,198,266,000
KRA 3	24,262,286,000	18,693,186,000	18,949,186,000
KRA 4	723,000,000	822,000,000	845,000,000
KRA 5	1,010,000,000	662,500,000	637,500,000
MGT	1,781,480,000	1,648,033,000	1,643,195,000

7.5.3 Funding Sources include bilateral (direct support to institutions from development partners), budget support and institutional development funds. The Chart below highlights the key sources of funding under SIP II.

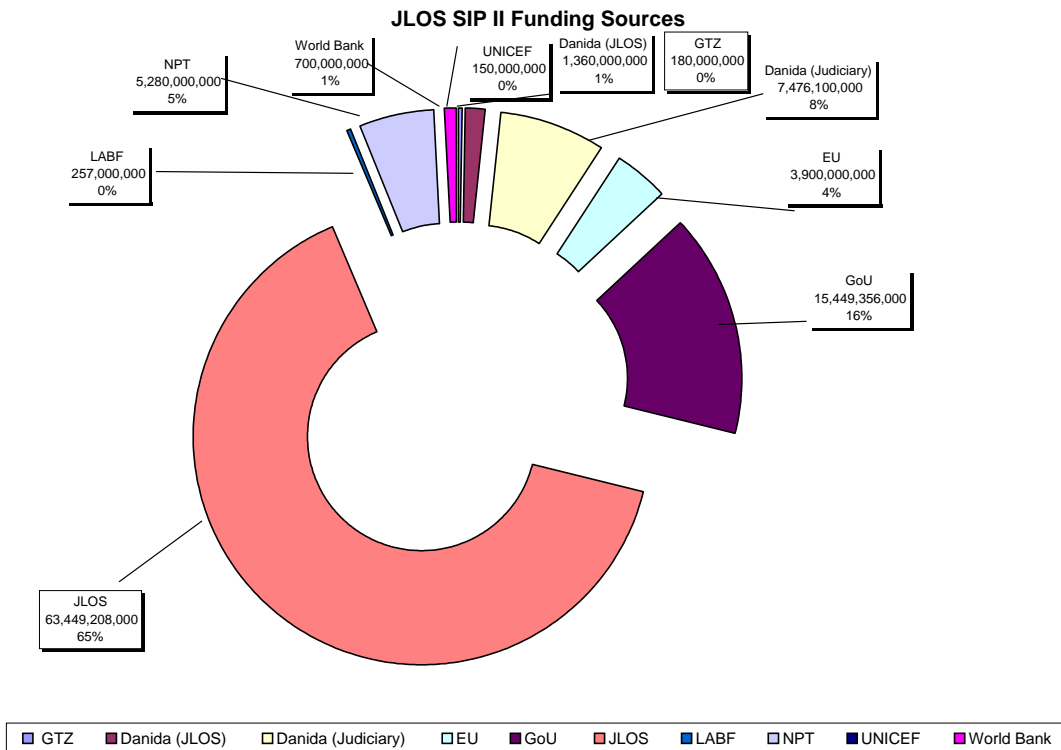

7.5.4 In the table below, the recurrent expenditure budget is growing by over Shs 10 Bn a year whereas the development budget has varied from Shs 30 to 35 Bn for the past two years and will continue through the SIP II period. However, as is evident from the priorities in the Key Result Areas (chapter 3) and the funding gaps covered in this chapter and the annex, greater targeting of recurrent funds to allowances, training and general supplies will be necessary to realise development funds for capital expense and infrastructure renovations (*See annex on MTEF indicative figures*).

Table 12 : MTEF 2006/07							
Shillings Bn		Wage	Non-Wage Recurrent	Domestic Development	Donor Project	Total excl. Donor	Total incl. Donor
(November 2005 edition)							
JUSTICE/LAW AND ORDER							
154	Uganda Registration Bureau	0.10	0.05	-	-	0.15	0.15
144	Uganda Police (incl LDUs)	41.83	33.42	3.28	-	78.54	78.54
145	Uganda Prisons	10.04	10.40	1.44	-	21.88	21.88
009	Internal Affairs	2.21	18.87	0.27	2.51	21.34	23.85
133	DPP	2.73	1.19	0.30	-	4.22	4.22
007	Justice Court Awards (Statutory)	-	2.05	-	-	2.05	2.05
007	Justice, Attorney General excl Compensation	1.48	2.50	19.37	1.87	23.35	25.22
007	Justice, Attorney General - Compensation	-	2.24	-	-	2.24	2.24
101	Judiciary (Statutory)	7.51	7.58	3.90	1.56	18.99	20.55
148	Judicial Service Commission	0.56	0.93	0.05	-	1.54	1.54
105	Law Reform Commission (Statutory)	0.48	1.53	0.20	-	2.21	2.21
109	Law Development Centre	-	1.18	-	-	1.18	1.18
SUB-TOTAL JUSTICE/LAW AND ORDER		66.93	81.91	28.81	5.94	177.65	183.64

Source: MoFPED MTEF Figures

The JLOS institutions are undertaking strategic planning processes and these discussions will further inform the overall JLOS budget. The comprehensive indicative work plan and budget for the medium term is attached as **Annex G** and a summary of costs per key result area is highlighted in the table below:

Table 13: Summary Budget per Key Result Area- Total Estimated Cost over the Medium Term 2006/07- 2008/9 (Uganda Shillings)

Priority Outcome	Budget			Total
	2006/7	2007/8	2008/9	
JLOS SO 1: Promote Rule of Law and Due Process				
1.1. Ensure Certainty of Laws & Predictability of Procedures	1,097,500,000	880,000,000	730,000,000	2,707,500,000
1.2. Foster Independence of the Judicial Process	-	-	-	-
1.3 Enhance Due Process	730,000,000	180,000,000	180,000,000	1,090,000,000
1.4. Enhance Accountability and Ethics in JLOS institutions	322,000,000	45,000,000	30,000,000	397,000,000
Sub-total	2,149,500,000	1,105,000,000	940,000,000	4,194,500,000
JLOS SO 2: Human Rights Culture Fostered				
2.1. Enhance human rights awareness and practice	1,840,000,000	1,835,000,000	1,835,000,000	5,510,000,000
2.2. Reduce Incidence of specific human rights violations	4,443,266,000	6,013,266,000	6,363,266,000	16,819,798,000
2.3. Foster Environment for Human Rights NGOs and Private Sector to effectively participate in JLOS	-	-	-	-
Sub-total	6,283,266,000	7,848,266,000	8,198,266,000	22,329,798,000
JLOS SO 3: Enhance Access to Justice				
3.1. Ensure more rationalised physical access and availability of JLOS institutions	18,847,286,000	12,266,186,000	12,497,186,000	43,610,658,000
3.2. Minimise Financial Bottlenecks hampering access to justice	190,000,000	40,000,000	-	230,000,000
3.3.Promote Alternative dispute resolution and innovative approaches	4,960,000,000	5,490,000,000	5,880,000,000	16,330,000,000
3.4.Strengthen the capacity and role of Executive Committee Courts	25,000,000	402,000,000	372,000,000	799,000,000
3.5.Enhance Quality of Justice	240,000,000	495,000,000	200,000,000	935,000,000
Sub-total	24,262,286,000	18,693,186,000	18,949,186,000	61,904,658,000
JLOS SO 4: Reduce Incidence of Crime, Promote Safety of the Person and Security of Property				
4.1. Enhance JLOS response to crime	320,000,000	456,000,000	449,000,000	1,225,000,000
4.2. Recidivism rates reduced	190,000,000	200,000,000	230,000,000	620,000,000
4.3. Crime Prevention Strategies Developed and Implemented	213,000,000	166,000,000	166,000,000	545,000,000
4.4. Safety of the Person and Security of Property enhanced	-	-	-	-
Sub-total	723,000,000	822,000,000	845,000,000	2,390,000,000

Priority Outcome	Budget			Total
	2006/7	2007/8	2008/9	
JLOS SO 5: JLOS Contribution to Economic Development				-
5.1 Conducive strategies developed and implemented to support competitiveness and wealth creation	720,000,000	497,500,000	497,500,000	1,715,000,000
5.2. Non Tax Revenue	115,000,000	15,000,000	15,000,000	145,000,000
5.3. JLOS Contribution to an Environment that Enables Uganda comply with and take advantage of regional bilateral and international trade agreements strengthened	175,000,000	150,000,000	125,000,000	450,000,000
Sub-total	1,010,000,000	662,500,000	637,500,000	2,310,000,000
Program Management	1,781,480,000	1,648,033,000	1,643,195,000	5,072,708,000
				-
Total	36,209,532,000	30,778,985,000	31,213,147,000	98,201,664,000

CHAPTER 8: TRANSITION ARRANGEMENTS FROM SIP I TO SIP II

As indicated throughout the strategy, SIP II is a build up onto SIP I and there is need to identify key processes that have to be undertaken to ensure a smooth transition phase and continuity of reform programmes and activities. Key among the issues and processes highlighted are the expansion of focus areas from two to four (Commercial and criminal justice to land and family justice) and revision of management structures and processes at national and local levels. As such, a transition phase of 6 months is necessary in the first year of SIP II (July to December 2006) and below is a highlight of some of the key arrangements that will be made.

8.1 Expansion of four focus areas

With the expansion of the focus areas from two (Commercial and Criminal Justice) to four (including Land and Family Justice) over the medium term, the Sector will identify and initiate engagement with key stakeholders in those areas and encourage their participation and understanding of the sector, its policy framework and operations. This will involve a continuous series of meetings and induction sessions which will be managed by the Secretariat with support from institutional PPUs.

8.2. Reconstitution of the various management Structures

A number of key changes are being made to the management structures to strengthen their capacity to undertake the challenging process of managing the sector. For instance, with the expansion of the Leadership and Steering Committees, the Sector will engage the identified offices and encourage their participation in JLOS activities through a series of activities including meetings. The JLOS Leadership facilitated by the Senior Technical Advisor will drive this process by providing briefs, communicating, initiating and following through with meetings.

8.3 Establishment of Working Groups under the Four Focus Areas:

Under SIP I, management of the reform process was largely through two Working Groups of the Technical Committee on Commercial and Criminal Justice. In SIP II, management will be based on four Working Groups under the four Focus Areas and the Budget Working Group as the fifth (see chapter 5). The new Working Groups (Land and Family) need to be established while the older WGs (Commercial and Criminal) need to be reconstituted to allow for new members e.g. CSOs, Private Sector and other institutions. In addition, representation from JLOS institutions to the WGs now comprises of Technical Persons and members of the PPUs. The process requires due consideration to sensitise JLOS staff, identify and nominate key representatives, constitute the Working Groups, elect leaders and convene meetings and the Sector will undertake these activities from July- September 2006.

8.4 Integration of parallel structures at the National level

The Sector will integrate key parallel structures at the national level including the Chain linked Initiative and the Case Backlog Reduction Project. Evaluations will be conducted in the first quarter) to draw out lessons from the pilots and existing structures will be merged. Committee members on these projects will be appointed onto JLOS management structures (as necessary) and existing programmes/ activities will be streamlined and integrated into mainstream JLOS programmes during the development of annual work plans and budgets. From July 2006, the Two Technical Assistants (TAs) currently seconded from the MoJCA PPU to the Case Backlog project will liaise directly and continue to channel information from the various structures mentioned above through the sector Secretariat to the Working Groups and Technical Committee.

8.5 Establishment of JLOS Coordination Committees (JCC)

This refers to the reconstitution of the various committees at the local level (including Chain Linked, Case Backlog and Community Service) into the JCC, based on the Community Service District Committees. Official communication to this effect will be made by the JLOS Leadership Committee to all districts and regions within the first three months of SIP II. Support of the Sector Secretariat and various Working Groups will be utilised to achieve this result.

8.6 Financial Management- Rationalisation of the Three PAF protected funds

The three PAF protected funds of Case Backlog Reduction, SWAP Development Fund and Commercial Justice Reform Programme Fund will be rationalised and amalgamated into one fund to streamline funding, planning and budgeting under SIP II. This amalgamation will be reflected in the SIP II Budget and annual working plan 2006/07.

8.7 Enhancing awareness and profile of JLOS among staff and at higher levels

Over the course July 2006- June 2007, the sector will undertake an intensive and comprehensive information strategy of JLOS SIP II among institutional staff and the public to raise awareness and encourage buy in to identified priorities and reform programmes. This will be through numerous ways to be highlighted by the Information Dissemination Strategy.

At a higher level, JLOS will seek to enhance political support of the Cabinet and Parliament for SIPII through implementation of its Lobbying Strategy and other modalities including Cabinet Memos and Press Briefs. These activities will be continuous over the course of SIP II.

8.8 Developing Partners Involvement in the Uganda Joint Assessment Strategy (UJAS)

The ongoing national process of re-aligning development partners' involvement in the different sectors under the UJAS to ensure more effective development partner engagement in areas of specific competence will have an impact on the structures, reporting and linkages that currently exist between the Government of Uganda/ JLOS and development partners. The transition phase will therefore focus on re-adjusting GoU-Development Partner structures and linkages to fit within the new UJAS requirements and enhance co-ordination under SIP II.